

DONGFENG NAMMI 01 MANUAL



Table of Contents

[Table of Contents](#)

[Overview](#)

[Safety Information](#)

[Charging Safety](#)

[In Case of an Accident](#)

[Graphic Index](#)

[Safety](#)

[Supplementary Restraint System](#)

[Seat Positions](#)

[Before Driving](#)

Pre-Drive Checks

Inspection Items

Correct Seating Position for the Driver

Door Ajar Warning

Interior Door Handles

Charging Port

Charging Precautions

Charging Instructions

Seat Adjustment

Front Seat

Rear Seat

Steering Wheel Position Adjustment

Rearview Mirror Adjustment

Internal Rearview Mirror

Light Locations

External Lights

Interior Lighting

Windshield Wipers And Washer

Electric Windows

When Driving

Driving Techniques

Instrument Cluster

Indicator and Warning Lights

Driving Modes

Safe Parking

Electric Power Steering (EPS) System

Brake System Description

Hydraulic Brake System

Parking Brake System

Yellow light

Autonomous Emergency Braking (AEB)

Adaptive Cruise Control (ACC)

Parking Assistance

Reverse Camera

Panoramic View

Vehicle Equipment

Heating And Air Conditioning

Air Conditioning Refrigerant

Air Conditioning Filter

Sun Visors

Storage Devices

Horn Switch

In-Vehicle Infotainment

Safety and Attention

Audio-visual system

Home Display

Vehicle Settings

Air Conditioning

Emergency Situations

Hazard Warning Lights

Onboard Tools

Fuse Replacement

Bulb Replacement

Jump Starting

General Description

Towing a Trailer

Maintenance

Maintenance Overview

Coolant Replacement

Power Battery

Maintenance

Windshield Wipers And Washer

Adding Windshield Washer Fluid

Tire and Wheel Inspection

Checking Tire Pressure

Vehicle Cleaning

Cleaning the Wheels

Interior Cleaning

Floor Mats

Seat Belts

Recycling and Environmental Protection

Technical Data

General Technical Characteristics

Overall Dimensions

Specification and Capacity of Main Liquids

Vehicle Identification

Vehicle Identification Number and Product Label

Microwave Window

Event Data Recording System (EDR)

Other ManualsLib Projects

Preface



Thank you and congratulations on your purchase of a Dongfeng brand vehicle.

To ensure a comfortable and enjoyable driving experience and to minimize malfunctions, it is essential to read this manual carefully before use and operate the vehicle as suggested in the manual.

The pictures, data, and explanations in this manual correspond to the product definition at the time of compilation. The images in this manual are only for the introduction of usage methods.

The appearance, interior, and technical specifications of the vehicle are continuously improved, and the pictures, data, and explanations in this manual are not to be used as criteria for ordering and acceptance.

This manual includes introductions to various configurations of the above-mentioned models. Therefore, some equipment and functions may not be available in your vehicle; the specific configuration is subject to the actual vehicle.

In this manual, some equipment/functions are marked with “*”, indicating whether the equipment/function is available depending on the equipment/functions of your vehicle.

“**WARNING**”, “**CAUTION**”, “**NOTE**”, and certain special symbols will frequently appear in this user manual. Pay special attention to these contents, as ignoring these warnings may result in personal injury or damage to your vehicle.

“ **WARNING**” indicates that failure to follow the instructions could result in serious personal injury or even death.

“ **CAUTION**” means that dangerous or unsafe practices may cause personal injury or vehicle damage.

“ **NOTE**” provides useful information.

The term “occupants” in this manual refers to both the driver and passengers.

The “dealership” mentioned in this manual refers to the “Dongfeng-exclusive dealership”.

Please use and maintain your vehicle according to the instructions in this manual and the paper version of the “Usage and Quality Guarantee Manual” provided with the vehicle to ensure technical and quality assurance.

Warning to Users

1. Before using the vehicle, please be sure to read this manual carefully, and follow the operating methods indicated in this manual during the use of the vehicle to ensure familiarity with the vehicle's operation and maintenance as well as safe driving. Our company will not be responsible for losses caused by improper use of the vehicle.
2. Please be sure to perform regular vehicle maintenance and servicing in accordance with the provisions of this vehicle's quality assurance policy.
3. To accommodate drivers of different sizes, the driving position can be adjusted as follows:
 - Front and rear adjustment, backrest tilt adjustment;
4. Wearing seat belts is an essential safeguard for the safety of all passengers in the car. Adults should adjust their seat belts according to their body size, and children should correctly choose and use child restraints and seat belts in accordance with the relevant requirements in this manual.
5. Seat belts must be worn to ensure the airbags function effectively.
6. Pre-driving inspection:
 - Check if the vehicle lights are functioning normally;
 - Cleanliness of the windshield and interior and exterior rearview mirrors, and condition of the wiper;
 - Position of the interior and exterior mirrors;
 - Tire Pressure and Tire Wear Condition. The condition of the tires directly affects the vehicle's power, economy, and ride comfort, and is more related to driving safety. Please use and maintain the wheels correctly according to regulations; tire pressure should be checked when the tires are cold;
 - The liquid level height of coolant, brake fluid, and windshield washer fluid;
 - The condition of the 12V battery.
7. Check the warning lights before the vehicle starts.
8. Operation of the drive motor:
 - When the 12V battery is low, the vehicle will not start or operate;
 - When starting the vehicle, press the brake pedal.
9. Brakes:
 - It is strictly forbidden to glide without power during the driving process of the vehicle. Otherwise, the vacuum booster will not function, significantly increasing the force needed to press the brake pedal, greatly reducing braking efficiency;
 - During emergency braking or braking on slippery roads, ABS can prevent wheel lock-up, contributing to the stability of the driving direction. However, careful and safe driving is still necessary.
10. About the combined instrument warning lights:
 - If red warning lights (such as power battery, drive motor, brake, etc.) illuminate on the instrument cluster while driving, stop safely as soon as possible, check the vehicle according to the instructions in this manual, and contact the dealership if necessary;
 - If a yellow warning light (such as ABS, tire pressure, etc.) illuminates on the combination meter while driving, check the vehicle according to the instructions in this manual, and if necessary, contact the dealership.
11. Before traveling, you should fully consider the journey and be aware of charging stations along the route, to avoid the vehicle breaking down due to insufficient power and the absence of charging stations.
12. When charging a new energy vehicle unattended, ensure that the power supply lines and plugs are in good condition and have sufficient electrical carrying capacity. When the power battery is fully charged, it will automatically stop charging.
13. Orange high-voltage warning labels are attached to high-voltage parts. Please pay attention to the content requirements on the warning label. To avoid electric shock, it is forbidden to touch high-voltage parts

Warning to Users

- and high-voltage cables (orange) and their connectors.
14. If the orange high-voltage cable on the vehicle is exposed or damaged, do not touch it, stop using the vehicle, and contact the dealership immediately.
 15. In case of vehicle failure please press the power-off switch directly, leave the vehicle, and contact the dealership.
 16. If the vehicle catches fire, use a fire extinguisher suitable for electrical fires (such as a water-based fire extinguisher) to extinguish the fire. If the fire is large, stay away from the vehicle immediately and contact the fire department, informing them that it is a new energy vehicle.
 17. If using water to extinguish the fire, use a large amount of water from a distance. Trying to extinguish electrical fires with a small amount of water (such as from a garden hose) is dangerous.
 18. Although the open flame may have been extinguished, the vehicle may still reignite. Please continue to use a fire extinguisher or a large amount of water to cover and cool the vehicle for a period of time, and keep monitoring to prevent reignition.
 19. It is strictly forbidden to drive through water if you do not know the depth of the water or if the water level exceeds the lower edge of the car body. If the vehicle is partially submerged in water: press the power-off switch directly and escape the vehicle immediately. Before salvaging the vehicle, it is necessary to wait until there are no bubbles and sizzling sounds on the water surface and the power battery is depleted before beginning salvage operations to prevent electric shock.
 20. When a new energy vehicle is driving, the sound of the vehicle is very low, which may not be perceived by pedestrians on the roadside. When driving, pay attention to slowing down, avoid pedestrians on the roadside, and honk the horn to remind if necessary.
 21. Any installation of electrical accessories must be connected according to the specified power connection position and wiring method and operated by dealerships. Non-professional maintenance personnel are prohibited from dismantling or modifying electrical equipment, otherwise, serious consequences such as short circuits, burning out of electrical equipment, and fires may occur.
 22. Safety Tips: Follow the following important driving rules to help ensure the safety of drivers and passengers throughout the journey!
 - - Strictly adhere to traffic rules and drive safely;
 - - Do not drive after drinking alcohol or taking medications;
 23. When applying film inside the windshield, take special care not to let water enter the dashboard; do not place wet umbrellas, water cups, etc., on the dashboard during daily use, as water entering the dashboard may cause damage to instrument appliances.
 24. When charging after washing the car or driving in the rain, first use a dry cloth to clean the water around the charging port before connecting the charging power source. It is strictly forbidden to wash high-voltage components and wiring harnesses directly with water.
 25. Even if the drive motor is turned off, the cooling fan may operate without warning, so as long as the powertrain hatch cover is opened, you must always be vigilant to avoid injury.
 26. This vehicle is not permitted to be modified without authorization. Modification will affect its performance, safety, or durability, and may violate policies and regulations. Damage or performance problems caused by modification will not be covered by our warranty.

Table of Contents

Overview	0
Safety	1
Before Driving	2
When Driving	3
Vehicle Equipment	4
In-Vehicle Infotainment	5
Emergency Situations	6
Maintenance	7
Technical Information	8

0. Overview

High Voltage Component Location Diagram	8
Safety Information	9
High Voltage System Warning Sign	9
New Energy Vehicle Description	9
Charging Safety	11
Vehicle Submerged in Water	11
In Case of an Accident	11
Graphic Index	12

High Voltage Component Location Diagram

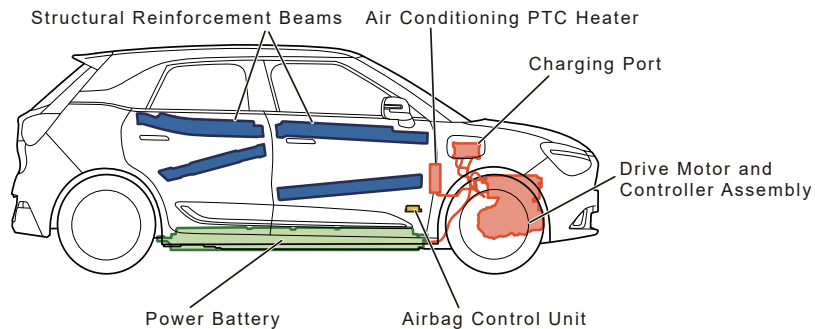
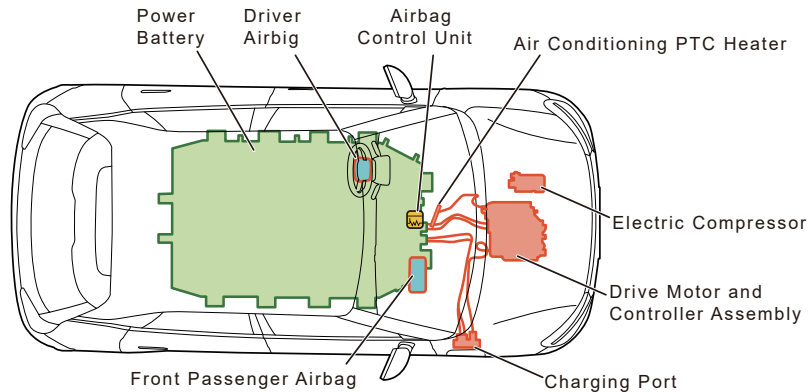

High Voltage System Warning Sign



Electrical components on the vehicle with this warning sign are part of the high-voltage system and may pose a risk of electric shock.

⚠ WARNING

- All private repairs to the high-voltage system (high-voltage components, high-voltage cables, connectors, high-voltage power batteries) are strictly prohibited, as they may pose a fatal risk to you or others. If you need to repair the high-voltage system, please contact a dealership.
- Serious burns or electric shocks can lead to death.

New Energy Vehicle Description

New energy vehicles operate similarly to traditional fuel vehicles. The main difference between new energy vehicles and traditional fuel vehicles is that new energy vehicles use electricity instead of fuel.

Therefore, it is recommended that you carefully read the descriptions of these new energy vehicles.

Types of Onboard Batteries

Your new energy vehicle has 2 types of batteries:

- High-voltage power battery;
- 12V battery, the same as in traditional fuel vehicles.

High Voltage Power Battery

The high-voltage power battery stores electrical energy, providing power to the vehicle's drive motor, electric compressor, and other high-voltage components, while also charging the 12-volt battery.

Like all batteries, it discharges after use and must be regularly charged. Please do not wait until the battery is depleted before charging.

The charging speed depends on the type of specific wall outlet or public charging terminal you connect to.

The range of your vehicle depends on the remaining battery power, as well as your driving style, outdoor temperature, and road conditions.

👁 CAUTION

- The optimal storage temperature for the power battery should be maintained between 20°C and 35°C.
- The humidity of the power battery storage environment should be kept between 30% and 70%.
- The power battery should be stored in a shaded environment to avoid direct sunlight exposure.
- The vehicle parking and charging environment should be dry and ventilated, with no flammable or explosive materials nearby, and away from heat sources.
- For long-distance travel, ensure that the State of Charge (SOC) is above 50% before using the vehicle.
- When the vehicle is parked for an extended period, the optimal SOC range for battery storage is 50% to 70%. Additionally, charge the battery slowly to full once every three months, then discharge it to an SOC of 50% to 70% before parking again.
- If the vehicle is parked for a long time without charging as required, it may cause excessive battery discharge, thereby reducing the performance of the power battery. Dongfeng will not assume any related responsibilities for vehicle malfunctions and damage caused by this, including quality guarantees.

12V Battery

Additionally, like traditional fuel vehicles, your vehicle has a 12V battery.

It also powers the vehicle's low-voltage electrical devices, such as lights, wipers, audio-visual equipment, and braking assistance.

The high-voltage power battery may automatically charge the 12V battery at regular intervals.

WARNING

When the high-voltage power battery is charging the 12V battery, opening the car door will automatically stop charging the 12V battery. However, there is a risk of electric shock in the following cases:

If the front engine compartment cover is not properly closed, opening the hood directly may pose a risk of electric shock.

If the front engine compartment cover is opened through unofficial means, there may be a risk of electric shock.

Regenerative Braking and Energy Recovery

When driving, if you release the accelerator pedal or lightly press the brake pedal, there may be a noticeable braking effect, which is normal.

This is because the drive motor participates in braking (regenerative braking) and acts as a generator to recover electrical energy for the power battery, achieving energy recovery.

During the first few kilometers of driving with a full battery, regenerative braking will be reduced.

At this time, you might feel uncomfortable, so always use the brake pedal for braking when needed, rather than relying on motor braking.

Silence

New energy vehicles are especially quiet when driving at low speeds. You may not be used to it, and other nearby vehicle drivers might not be either.

Therefore, the vehicle is equipped with a low-speed warning sound function. When driving at low speeds, this function emits a warning sound.

It alerts pedestrians and surrounding vehicles, serving as a precaution. When new energy vehicles are driving at high speeds, you may hear some unfamiliar noises, such as wind noise, tire noise, etc. This is because the motor is silent, allowing other noises to be heard clearly.

For models equipped with a brake vacuum pump, the brake vacuum pump will automatically operate and produce a "buzzing" sound each time the vehicle is powered on or the brake pedal is pressed. This is a normal phenomenon and will quickly disappear.

WARNING

Because new energy vehicles are very quiet, when you leave the car, please make sure to check and confirm that the parking brake is engaged. Otherwise, it may cause a serious accident or even personal injury.

Charging Safety

- When charging a new energy vehicle unattended, ensure that the power supply lines and plugs are in good condition and have sufficient electrical carrying capacity.
- When the vehicle is fully charged, it will automatically stop charging, but the charging gun should still be unplugged in a timely manner.
- When charging after washing the car or driving in the rain, first use a dry cloth to clean the water around the charging port before connecting the charging power source.
- It is strictly forbidden to wash the charging port directly with water.

Vehicle Submerged in Water

- It is strictly forbidden to drive through water if you do not know the depth of the water or if the water level exceeds the lower edge of the car body.
- If the vehicle is mostly or completely submerged in water, please immediately leave the vehicle and the water area.
- Before salvaging the vehicle, ensure there is no high voltage before carrying out the salvage operation to prevent electric shock.

In Case of an Accident

Stay Away from the Vehicle

- All occupants must immediately stay away from the vehicle.

Beware of Electric Shock

- If high-voltage components or cables are damaged, do not touch any high-voltage components or any cables, as this may cause electric shock and result in casualties.

Avoid Contact with Electrolyte

- If the power battery is damaged, causing the electrolyte to leak, do not touch it, as it may cause corrosive injuries.
- If you accidentally come into contact with the electrolyte, rinse the affected skin area or eyes with plenty of water for at least 5 minutes and seek medical attention immediately.

Fire Extinguishing

- If the vehicle catches fire, use a fire extinguisher suitable for electrical fires to extinguish the flames. If the fire is large, you should immediately move away from the vehicle, contact the fire department, and inform them that it is a new energy vehicle.

- If using water to extinguish the fire, use a large amount of water from a distance. Trying to extinguish electrical fires with a small amount of water (such as from a garden hose) is dangerous.
- Although the open flame may have been extinguished, the vehicle may still reignite. Please continue to use a fire extinguisher or a large amount of water to cover and cool the vehicle for a period of time, and keep monitoring to prevent reignition.

Contact dealership

- At any time, if the vehicle is damaged in an accident, please go to a dealership for repairs.

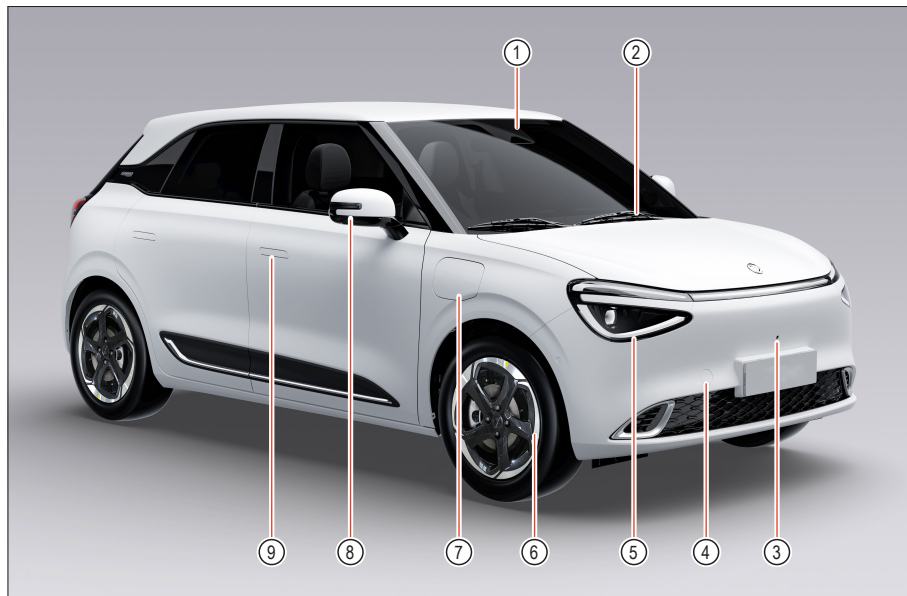

① Advanced Intelligent Driving Assistance System*

- Autonomous Emergency Braking (AEB)*
- Forward Collision Warning (FCW)*
- Lane Departure Warning System (LDW)*
- Lane Keeping Assist System (LKA)*
- Traffic Sign Recognition (TSR)*
- Intelligent Cruise Assist (ICA)*

② Front Windshield Wiper

③ Front Camera (360 Panoramic View)*

④ Front Towing Hook Location

⑤ LED Front Headlights

- Continuous Light with Breathing Light Language*
- Front and Rear Combination Lights with Breathing Light Language*
- Intelligent High and Low Beam*
- Automatic Headlight On/Off
- Electric Height Adjustment
- Headlight Delay Off

⑥ Tire Pressure Monitoring

⑦ Charging/Discharging Port

- External Discharge* V2L V2V

⑧ Electric Folding Rearview Mirror*

⑨ Retractable Door Handles

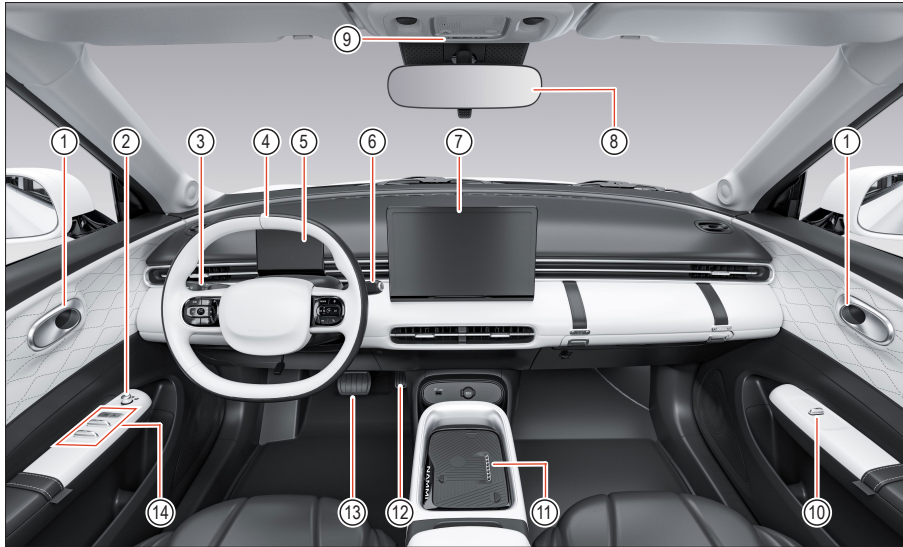

- ① Interior Door Handles
- ② Exterior Mirror Adjustment Lever
- ③ Light and Wiper Combination Switch
- ④ Multi-Function Steering Wheel
- ⑤ Instrument Cluster
- ⑥ Electronic Shift Lever
- ⑦ Central Control Display Screen*
 - Mobile Internet*
 - Mobile Connection/Mirroring*
 - 12-inch Large Screen
- ⑧ Internal Rearview Mirror
- ⑨ Microphone*
- ⑩ Front Passenger Window Switch
- ⑪ Wireless Phone Charging*
- ⑫ Accelerator Pedal
- ⑬ Brake Pedal
- ⑭ Driver's Window Master Switch and Central Lock Switch

Graphic Index

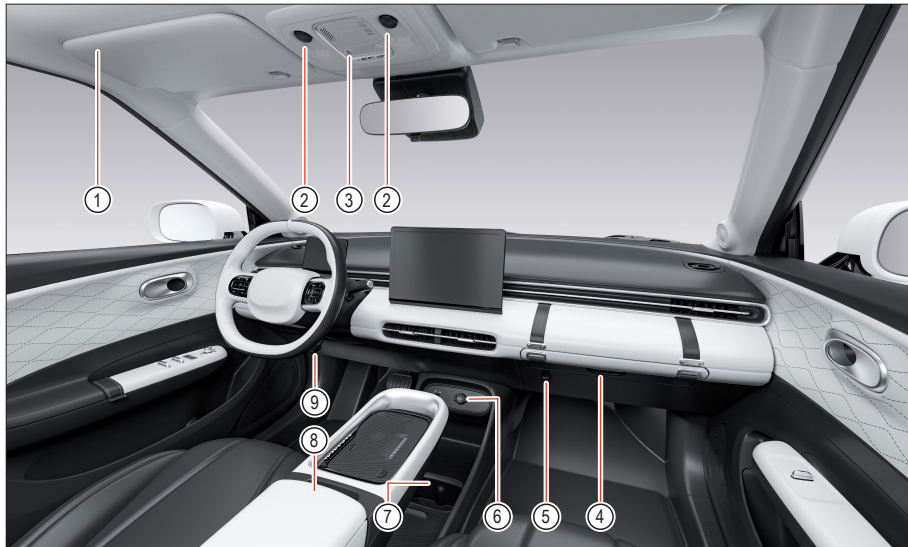

- ① Sun Visor
- ② Front Overhead Light Switch
- ③ Hazard Warning Light Switch
- ④ Special Drawer Storage Box
- ⑤ Hook
- ⑥ 12V Power Outlet and USB Port
- ⑦ Open Cup Holder
- ⑧ Central Armrest (with Storage Box)*
- ⑨ Steering Wheel Position Locking Lever

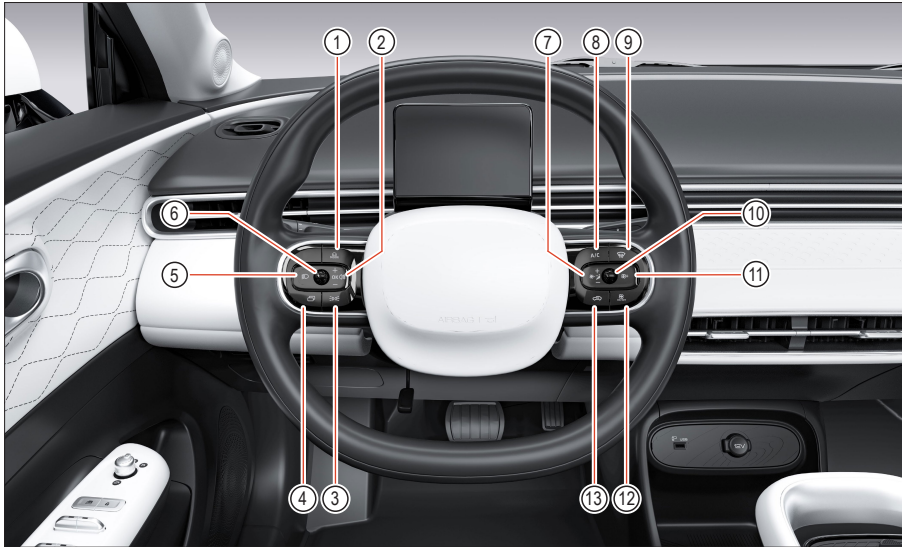

Steering Wheel 1* (with Light and Air Conditioning Control)

Left Side Multi-Function Buttons on the Steering Wheel:

- ① Driving Mode Switch Button
- ② Rear Fog Light Switch
- ③ Position Light Switch
- ④ Instrument Function Switching Button
- ⑤ Low Beam Light Switch
- ⑥ Instrument Function “OK” Button(Press)/ Instrument Brightness+ (Up) / Instrument Brightness- (Down)

Right Side Multi-Function Buttons on the Steering Wheel:

- ⑦ Decrease Air Volume Button
- ⑧ Air Conditioning (A/C) Switch - Compressor
- ⑨ Front Windshield Defogging Button
- ⑩ Airflow Mode Selection Button (Press)/ Temperature + (Flick Up)/ Temperature - (Flick Down)
- ⑪ Increase Air Volume Button
- ⑫ Air Conditioning (A/C) Control Button
- ⑬ Internal and External Circulation Switch Button

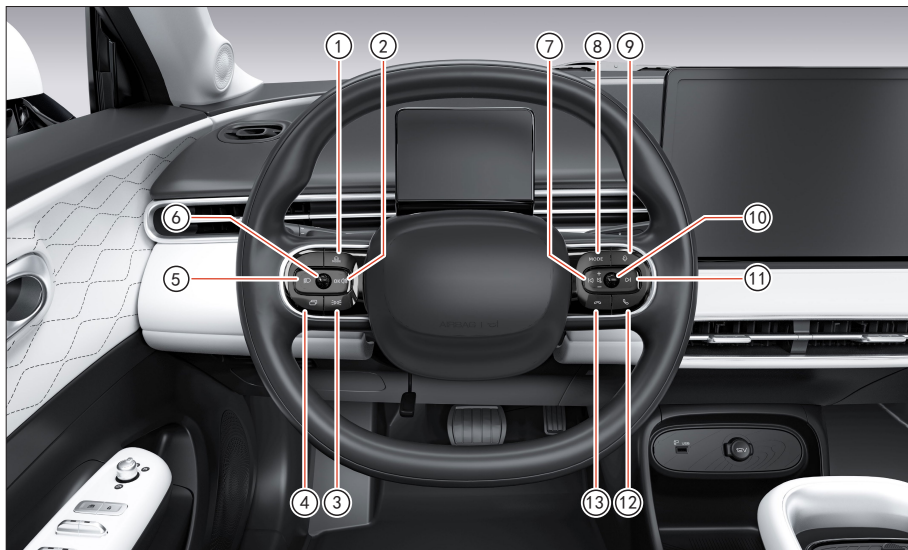

Steering Wheel 2* (with Lighting and Audio/Video Controls)

Left Side Multi-Function Buttons on the Steering Wheel:

- ① Driving Mode Switch Button
- ② Rear Fog Light Switch
- ③ Position Light Switch
- ④ Instrument Function Switching Button
- ⑤ Low Beam Light Switch
- ⑥ Instrument Function "OK" Button

Right Side Multi-Function Buttons on the Steering Wheel:

- ⑦ Previous Track Button
- ⑧ Audio Source Selection Button
- ⑨ Voice Wake-Up Button
- ⑩ Mute Button (Press)/
Volume + (Flick Up)/ Volume - (Flick Down)
- ⑪ Next Track Button
- ⑫ Bluetooth Phone Answer Button
- ⑬ Bluetooth Phone Hang Up Button

Steering Wheel 3* (with Cruise Control and Audio/Video Controls)

Left Side Multi-Function Buttons on the Steering Wheel:

- ① Driving Mode Switch Button
- ② Cruise Control Cancel Button
- ③ Custom Button
- ④ Instrument Function Switching Button
- ⑤ Cruise Control Function Button
- ⑥ Instrument Function "OK" Button(Press)/
Cruise Speed + (Flick Up)/ Cruise Speed - (Flick Down)

Right Side Multi-Function Buttons on the Steering Wheel:

- ⑦ Previous Track Button
- ⑧ Audio Source Selection Button
- ⑨ Voice Wake-Up Button
- ⑩ Mute Button (Press)/
Volume + (Flick Up)/ Volume - (Flick Down)
- ⑪ Next Track Button
- ⑫ Bluetooth Phone Answer Button
- ⑬ Bluetooth Phone Hang Up Button

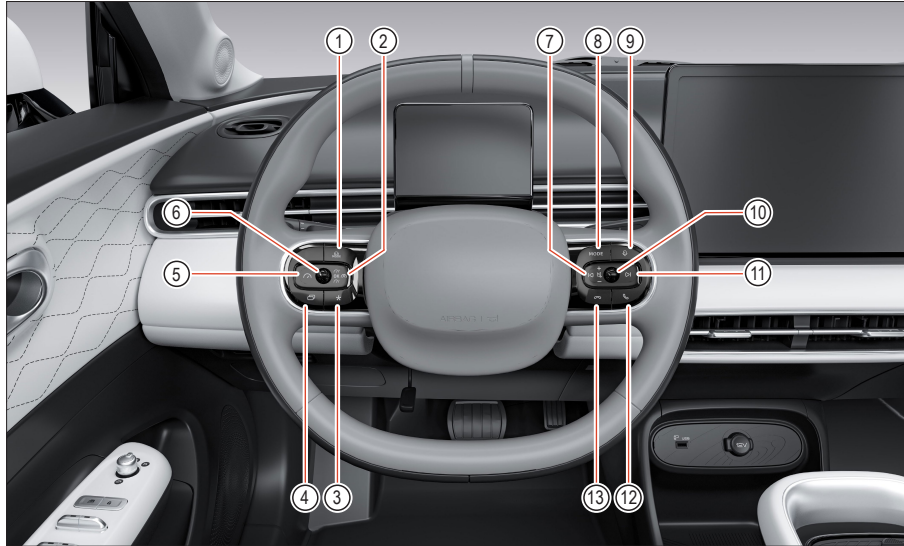

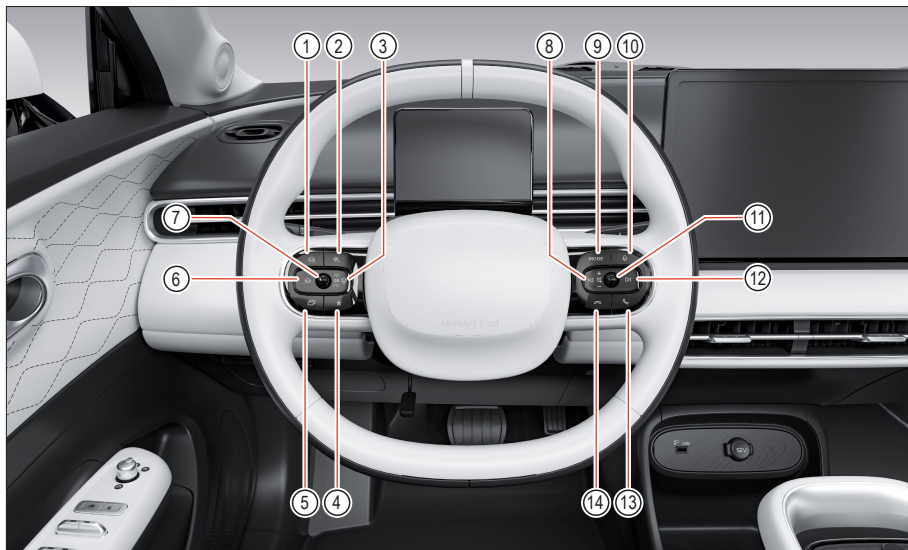

Steering Wheel 4* (with Intelligent Driving and Audio Control)

Left Side Multi-Function Buttons on the Steering Wheel:

- ① ACC Function Button
- ② ICA Function Button
- ③ Following Distance Increase Button
- ④ Custom Button
- ⑤ Instrument Function Switching Button
- ⑥ Following Distance Decrease Button
- ⑦ Instrument Function “OK” Button(Press)/
Cruise Speed + (Flick Up)/ Cruise Speed - (Flick Down)

Right Side Multi-Function Buttons on the Steering Wheel:

- ⑧ Previous Track Button
- ⑨ Audio Source Selection Button
- ⑩ Voice Wake-Up Button
- ⑪ Mute Button (Press)/
Volume + (Flick Up)/ Volume - (Flick Down)
- ⑫ Next Track Button
- ⑬ Bluetooth Phone Answer Button
- ⑭ Bluetooth Phone Hang Up Button

1.Safety

Safety Label Description.....	20	Situations Where Airbags May Accidentally	
Seat Belt.....	21	Inflate	32
Function of the Seat Belt.....	21	Airbag System Failure Warning.....	33
Correct Way to Wear a Seat Belt	21	Maintenance and Disposal of Airbags	34
Introduction to Seat belts	22	Child Passenger Safety	35
Pregnant Women and Special Occupants	23	Child Passenger Guidelines.....	35
Seat Belt Reliability Check	25	Child Seat Warning Labels.....	36
Maintenance of Seat Belts	25	Child Seat Fixation Devices	37
Repair and Disposal of Seat Belts	25	Selection of Child Seats	38
Supplementary Restraint System.....	26	Child Safety Lock	43
Introduction to the Supplementary Restraint		Passenger Window Disable Switch.....	43
System	26		
Precautions for the Supplementary Restraint			
System	27		
Collision Detection Area	29		
Conditions for Airbag Inflation	29		
Situations Where Airbags May Not Inflate.....	29		

Safety Label Description

Coolant Instruction Label

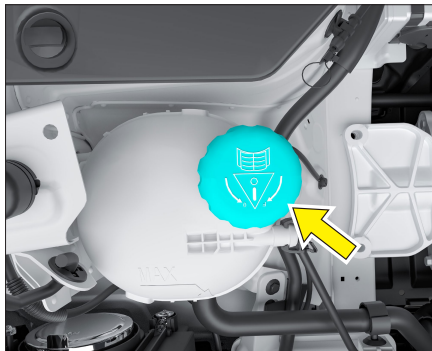

The coolant instruction label is engraved on the cap of the drive motor coolant reservoir.

Cooling Fan Warning Label

The cooling fan warning label is affixed to the top cover of the fan.

High Voltage Component Warning Label

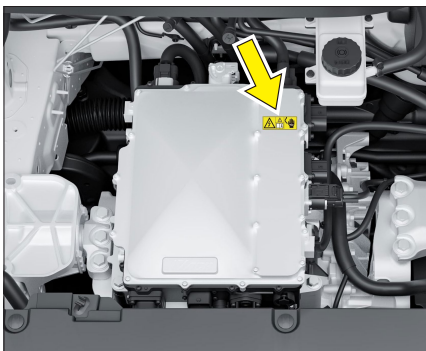

The high voltage component warning label is stuck on top of the high voltage integrated controller.

CAUTION

High voltage warning labels are affixed to high voltage components. To avoid the risk of electric shock, it is forbidden to touch high voltage components, high voltage cables (orange), and their connectors.

Child Safety and Airbag Warning Labels



Child safety and airbag warning instruction labels are located on the surface and inside of the front passenger sun visor.

Power Battery Warning Label

The power battery warning label is affixed to the power battery.

Function of the Seat Belt



During emergency braking or a collision, the seat belt restrains the driver and passengers on their seats, preventing secondary collisions with other parts inside the vehicle, while also ensuring optimal protection from the airbags.

⚠ WARNING

- All occupants, including pregnant women, should wear seat belts while the vehicle is in motion.
- For child occupants, please select and use the appropriate child restraint device.
- Always keep the seat belt properly fastened during the vehicle's operation.

Consequences of Not Wearing a Seat Belt

During a collision, occupants not wearing seat belts may be thrown out due to inertia, leading to injuries.

Even at low speeds, the force exerted on the body during a collision is significant, easily leading to secondary collisions.

Rear passengers must also wear seat belts correctly, as they could be thrown out in an accident. Unbelted rear passengers not only risk injuring themselves but also endanger other occupants in the vehicle.

Correct Way to Wear a Seat Belt

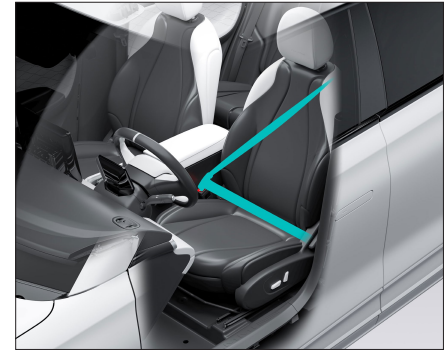

The seat belt should be placed over the body's skeletal structure. For the upper body, the upper part of the seat belt should fit snugly across the chest and over the shoulder. For the lower body, the lower part of the seat belt should fit snugly over the pelvic bones, and not rest on the abdomen.

Seat Belt

Introduction to Seat belts

Each seat in this vehicle is equipped with a three-point seat belt.

Front Seat Belts: Load-limited belts with pre-tensioners.

Rear seat belts: Standard seat belts.

The driver's seat belt is equipped with a not-fastened reminder feature, and the front passenger seat belt may be equipped with a not-fastened reminder feature. All occupants must properly wear seat belts every time they ride in the vehicle.

CAUTION

- Before fastening the seat belt, first adjust the seat's position and the backrest angle to a suitable position.
- The seat belt should be as tight as possible, as a loose seat belt greatly reduces its protective effect.

Seat Belt Locking

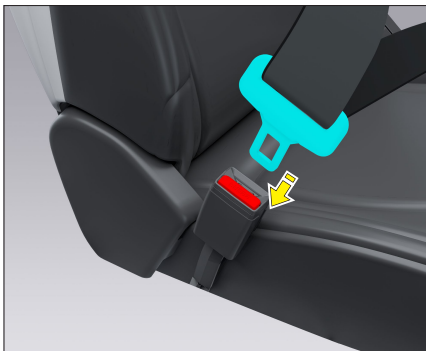

Slowly pull out the seat belt from the retractor, then insert the tongue into the buckle until you hear a "click" sound. Pull back on the seat belt to ensure it is securely locked.

Seat Belt Adjustment



Gently pulling the seat belt allows for adjustment of its length, enabling occupants to find a suitable position on the seat.

First, fasten the lower part of the seat belt lower across the hips, then pull up the upper part of the seat belt to ensure the lower part fits snugly against the body. This way, the sturdy pelvic bone can withstand greater impact forces, reducing the chance of abdominal injuries.

Seat Belt Release

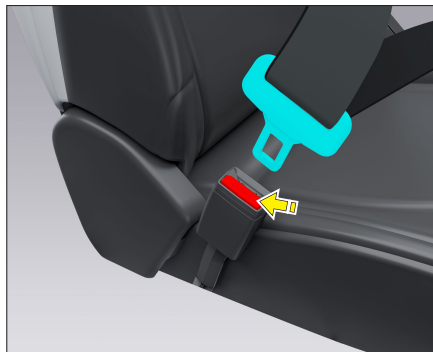

Press the red button on the buckle to release the seat belt lock. After unlocking, push the seat belt slightly towards the upper anchor point, and it will automatically retract into the retractor.

Rear Seat Belts

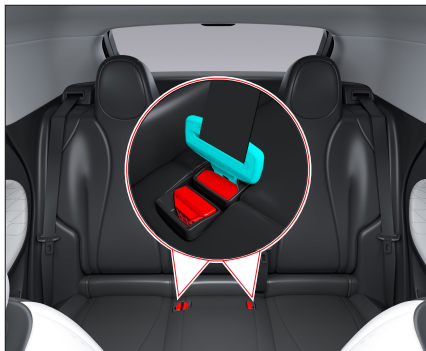

The method of wearing rear seat belts is the same as that for front seat belts.

 **CAUTION**

If the seat belt tongue is incorrectly buckled into another seat's buckle, it could position the occupant too far from the buckle. In a severe crash, the seat belt might move up to the occupant's abdomen, exerting force on the abdomen instead of the hip bone, potentially causing serious injuries.

Pregnant Women and Special Occupants

Pregnant Women

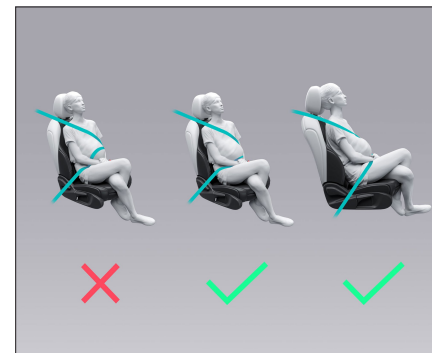

For pregnant occupants, the best way to protect both the pregnant woman and the fetus is to always use the seat belt correctly while driving or riding, ensuring the lap belt part is as low as possible across the hips.

Before driving, adjust the seat as far back as possible while still being able to comfortably control the vehicle.

Consult with a doctor at every prenatal checkup to ask if it's still safe to drive and follow the doctor's professional advice. When sitting in the front passenger seat, also move the seat as far back as possible to reduce injuries from airbag inflation.

Seat Belt

Persons with Disabilities

Persons with disabilities should use seat belts when riding in a vehicle. Consult with a doctor for professional advice.

CAUTION

- All occupants in the vehicle must wear seat belts when the vehicle is moving. For child occupants, the appropriate child restraint device should be correctly selected and used, and must be installed on the rear side seats.
- Always fasten the upper part of the seat belt snugly across the shoulder and chest, and do not let it pass behind the back or under the arm. When the seat belt crosses the shoulder, avoid the face and neck, but do not let it slip off the shoulder. Incorrect use of seat belts can cause serious injuries.
- If the seat belt passes under the arm, occupants may suffer serious injuries. In a crash, occupants may move forward too much, increasing the risk of head and neck injuries, and the seat belt force is mostly exerted on one side of the ribs, causing injuries.
- Do not use seat belt tongue substitutes to insert into the buckle to eliminate unbuckled seat belt warnings.

- Do not twist the seat belt when wearing it. A twisted seat belt increases pressure on the body, reducing its protective effect.
- Do not use one seat belt for multiple people; each seat belt is for one person only. If a seat belt is fastened around a child sitting on a passenger's lap in a crash, it can cause serious injuries.
- Because children are smaller in size, the vehicle's seat belts are not suitable for them. After fastening, the upper part of the seat belt may be too close to the head and neck, failing to effectively protect the child in an accident, and even causing greater injuries. Be sure to use a suitable booster cushion or child restraint device for the child's body and seat.
- Do not make any alterations to the seat belt, as it can hinder the retractor from effectively retracting the slack belt.
- If the fabric of the seat belt is worn or damaged, replace it with a new one.
- After the vehicle is involved in a collision, go to a dealership to check all seat belt assemblies, including retractors and locking buckles. Replace them if necessary.

Seat Belt Reliability Check

The seat belt retractor will lock the seat belt in the following three situations:

- When the seat belt is rapidly pulled out from the retractor;
- When the vehicle decelerates quickly;
- When the seat belt retractor is tilted at a large angle.

To check the reliability of the seat belt, grasp the upper part of the seat belt and pull it quickly; at this point, the retractor should lock the seat belt. If the retractor does not lock, go to a dealership for inspection or repair.

Maintenance of Seat Belts

Regularly check the seat belt and all its components (such as buckles, tongues, retractors, straps) for proper operation.

If any part of the seat belt is damaged, the strap is frayed, or other damages are found, replace the entire seat belt assembly. If there is dirt on the upper guide ring of the seat belt, the retraction speed of the seat belt may be slow, so it should be wiped clean with a clean, dry cloth.

When cleaning the seat belt strap, use neutral soap water or a solution suitable for cleaning car interiors and carpets. After cleaning, the seat belt strap should be completely dried before use. Do not retract a wet strap into the retractor, as it may cause damage to the retractor.

Repair and Disposal of Seat Belts

When the following situations occur, please go to a dealership for repair as soon as possible:

- When the vehicle has a frontal collision, but the seat belt tensioner does not work.
- When the seat belt retractor and surrounding components are scratched, cracked, or otherwise damaged.

Go to a dealership for seat belt inspection and repair.

When disposing of the seat belt retractor, you must comply with relevant safety regulations. Dealerships are familiar with these regulations and can provide consultation services.

Supplementary Restraint System

Introduction to the Supplementary Restraint System

1 Safety

The following contains important information about frontal airbags. Please read carefully before driving the vehicle.

The installation locations of airbags can be identified by the "AIRBAG" symbol. Airbags provide supplementary protection to properly worn seat belts but are not a replacement for them. In applicable accident situations, airbags offer additional protection.

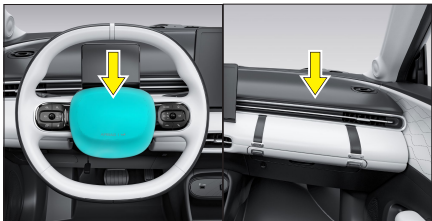

Frontal Airbags

The driver's frontal airbag is located in the middle of the steering wheel. The passenger frontal airbag is located inside the dashboard in front of the front passenger.

Frontal airbags inflate during severe frontal collisions, though similar impacts (like hitting a road ditch) can also cause inflation. The extent of the vehicle's damage (or apparent damage) is not a sufficient condition for frontal airbag deployment.

Frontal airbags help reduce the frontal impact force on the face and chest of the driver and front passenger in certain frontal collisions.

⚠ WARNING

Incorrect sitting posture may prevent airbags from providing their intended protection, and airbag deployment could even cause further injury. To avoid hazardous situations, always ensure that the driver and all passengers:

- Wear seat belts correctly, including pregnant women.
- Sit properly and stay as far away from the airbags as possible.
- Ensure there are no objects between the airbag and occupants.

👁 CAUTION

The inflation and deflation of the airbag occur in a very short time and can only work once, offering no protection against possible subsequent impacts.

- The dust produced during airbag deployment can irritate the skin and eyes and may exacerbate asthma in some individuals. After an accident with airbag deployment, thoroughly wash all exposed skin with water and mild soap.
- Many airbag system components become hot after inflation; avoid touching them to prevent burns.
- Move the driver and front passenger seats as far back as possible. The driver's seat position must ensure safe vehicle operation.
- Hold only the outer rim of the steering wheel to allow full airbag deployment.
- Always lean back against the seatback while driving. Do not lean forward or against the door or side windows. Otherwise, your body may enter the airbag deployment zone.

 CAUTION

- Keep both feet in the footwell in front of the seat. Do not place feet on the dashboard or other positions. Otherwise, your feet may enter the airbag deployment zone.
- Passengers shorter than 1.50 meters cannot wear seat belts correctly. Always use appropriate restraint devices for passengers under 1.50 meters.
- In some side impacts, rear impacts, rollovers, or lighter frontal impacts, frontal airbags may not deploy. Always wear seat belts to reduce injuries in different types of accidents.

Before driving, to avoid injury risks from high-speed airbag deployment, ensure:

- No people, animals, or objects between the occupants and the airbags.
- No accessories (like cup holders) installed in the airbag deployment area.
- No heavy, sharp, or fragile items in the pockets of the occupants' clothing.

Precautions for the Supplementary Restraint System

Recommendations for Effective Airbag Use

To effectively use airbags, it is recommended to:

- Always wear seat belts;
- Do not fix or attach any objects to the airbag cover in the middle of the steering wheel or the passenger airbag area on the dashboard, as this can hinder normal airbag function or cause injury during inflation;
- Do not place any objects between the body and the airbag;
- Do not drive holding the steering wheel spokes or placing hands on the airbag cover;
- Do not smoke while driving (risk of burns or injury when the airbag inflates);
- Passengers should not put their feet on the dashboard while the vehicle is moving;
- Children should sit on the rear side seats and use child safety restraint systems.

Airbag Safety Precautions

The Supplementary Restraint System (SRS) offers less protection to smaller individuals. Always wear seat belts correctly and maintain a distance from the steering wheel and dashboard.

The Supplementary Restraint System (SRS) is only for supplementary protection and cannot replace seat belts in an accident. Moreover, airbags can cause skin burns or other injuries.

To protect occupants promptly, airbags inflate rapidly. If an occupant is too close to or leaning on the airbag, the force of inflation might increase the risk of injury. Airbags deflate quickly after inflation.

The Supplementary Restraint System (SRS) only works when powered on.

Supplementary Restraint System

WARNING

- When airbags inflate, a loud noise and smoke release may occur. This smoke is non-toxic but does not indicate a fire. Avoid inhaling it, as it can trigger respiratory distress, especially in individuals with respiratory diseases. Leave the vehicle immediately and go to a place with fresh air.
- In some side impacts, rear impacts, rollovers, or lighter frontal impacts, frontal airbags may not deploy. Always wear seat belts to reduce injuries in different types of accidents.
- Many components of the Supplementary Restraint System become hot after inflation; avoid touching them to prevent burns.
- Do not place any objects between occupants and the steering wheel, on the dashboard, near front door trims, or near the front seats. Otherwise, when airbags inflate, the object may be thrown out, endangering the occupants.
- Do not modify any component or circuit of the Supplementary Restraint System. This is to prevent accidental inflation of airbags or damage to the Supplementary Restraint System.

WARNING

- Do not modify the vehicle's electrical system, suspension system, front structure, or side roof panels. This may cause the Supplementary Restraint System to malfunction.
- When repairing the Supplementary Restraint System and its surrounding components, it should be done by a dealership. Do not modify or cut the Supplementary Restraint System wiring.
- The frontal airbag can only provide effective protection when the driver is at a sufficient distance from the steering wheel.
- If the driver is too close to the steering wheel, the frontal airbag cannot provide effective protection when it inflates, and may cause serious or even fatal injuries. Therefore, sit upright against the seatback, and maintain a certain distance between the chest and the steering wheel.
- Front passengers should not be too close to the dashboard. Otherwise, when the frontal airbag inflates, it may cause serious or even fatal injuries, so sit upright against the seatback, maintaining a certain distance between the chest and the dashboard.

WARNING

- Do not let children stick their hands or heads out of the window. Otherwise, in a collision causing the frontal airbag to inflate, it may cause serious or even fatal injuries.
- Do not let children's heads, hands, feet, or faces near the front passenger frontal airbag. Otherwise, in a frontal collision, when the frontal airbag inflates, it may cause serious or even fatal injuries.
- Do not let children sit on a passenger's lap or be held by hand. Otherwise, in a collision, children may be thrown towards the dashboard, and when the frontal airbag inflates, it may cause serious or even fatal injuries.
- It is strictly prohibited to install rear-facing child restraint devices on the front passenger seats. Otherwise, in a collision, the child restraint system may be struck by the inflating front passenger airbag, causing serious injury or death to the child.

Collision Detection Area

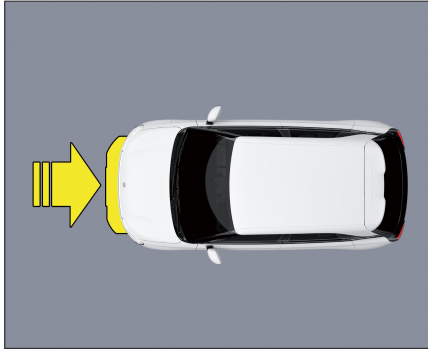

In the event of a collision, the system controls whether the frontal airbags inflate based on the angle and intensity of the impact detected by the collision sensors within the vehicle monitoring area (as shown above).

Conditions for Airbag Inflation

Main prerequisites for airbag inflation:

- Power supply. If the vehicle's power is off before a collision, the airbags cannot inflate.
- The direction of the vehicle impact matches the direction in which the collision sensors detect deceleration.
- The deceleration value detected by the sensors reaches the airbag inflation condition.

 CAUTION

- Whether airbags inflate depends only on the deceleration caused by the vehicle collision in the respective direction and is not directly related to the extent of vehicle deformation and damage or the severity of occupant injuries after the collision.
- National certified collision test conditions involve the vehicle colliding with an immovable, non-deformable obstacle at a speed of 50 km/h, under which conditions the frontal airbags inflate.

Situations Where Airbags May Not Inflate

When Rear-Ended by Another Vehicle

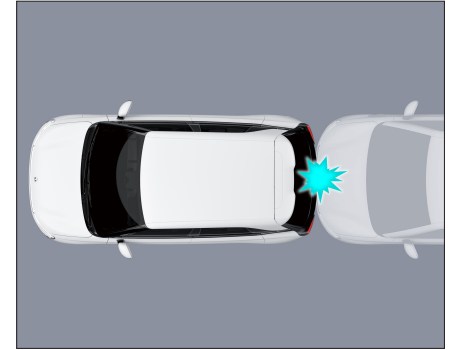

When the vehicle is only rear-ended or impacted from the rear, the frontal airbags will not deploy.

Supplementary Restraint System

When Side-Impacted by Another Vehicle

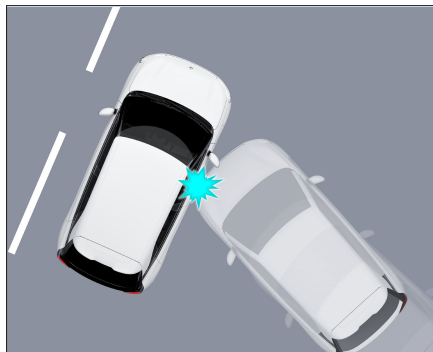

When the vehicle's side cabin area is impacted, the frontal airbags generally will not deploy.

However, depending on the angle and nature of the impact, the frontal airbags may still deploy.

When the Vehicle Collides with Guardrails or Other Vehicles from a Front-Side Angle



When the vehicle collides with road guardrails or other vehicles from a front-side angle, the frontal airbags may not deploy.

However, depending on the angle and nature of the impact, the frontal airbags may still deploy.

When the Vehicle Goes Under a Large Truck



When involved in a rear-end collision with a large truck and going under the vehicle, the frontal airbags may not deploy.

1

Safety

Vehicle Rollover or Lateral Rollover

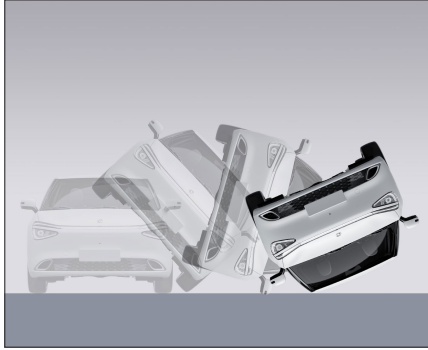

In the event of a rollover or lateral rollover accident, the frontal airbags may not deploy.

Frontal Collision with Pole-Like Objects such as Electric Poles or Trees



If the vehicle collides with thinner or less rigid pole-like objects such as electric poles or trees, the frontal airbags may not deploy.

They may deploy depending on the collision speed and area.

Vehicle Falls from a Height, Landing on Its Bottom

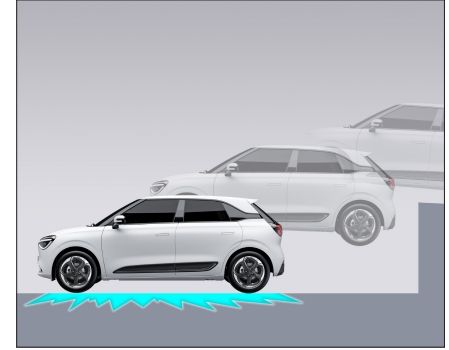

If the vehicle falls from a height and lands on its bottom, the frontal airbags may not deploy.

Supplementary Restraint System

Airbag System Failure

1
Safety

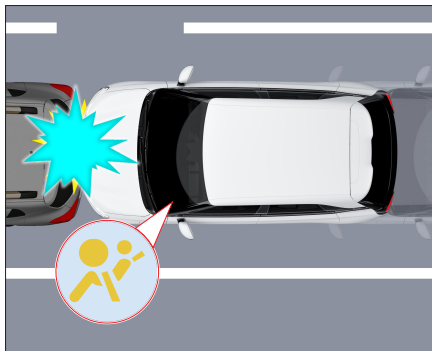

When the airbag system failure warning is not repaired promptly, the frontal airbags may not deploy.

 **CAUTION**

When the airbag system failure warning light is on, immediately visit a dealership for inspection.

Rear-End Collision with a Vehicle Moving in the Same Direction

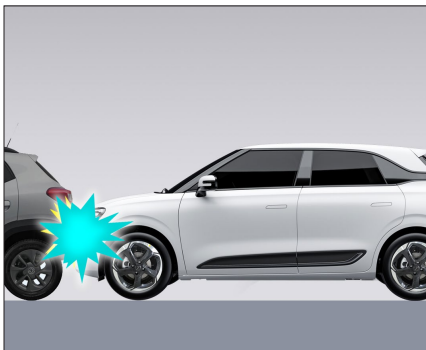

In the event of a rear-end collision with a vehicle moving in the same direction, the frontal airbags may not deploy.

Situations Where Airbags May Accidentally Inflate

Crossing Deep Potholes

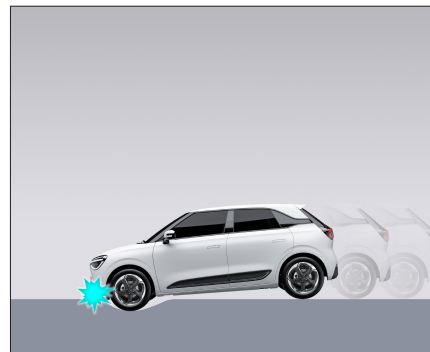

Crossing deep potholes, causing the front of the vehicle to hit the ground, may accidentally trigger the deployment of the frontal airbags.

Hitting Raised Objects or Curbs on the Roadside



Hitting raised objects or curbs on the roadside, or severe scraping of the undercarriage with road protrusions, may accidentally trigger the deployment of the frontal airbags.

Descending Steep Slopes, Front of the Vehicle Hitting the Ground

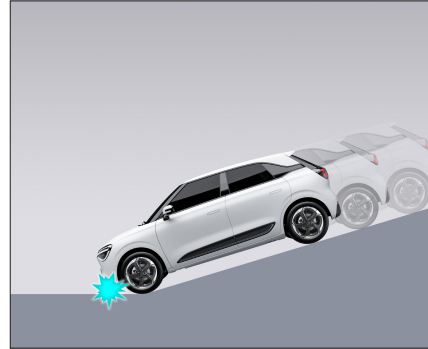

Descending steep slopes, with the front of the vehicle hitting the ground or objects like sand mounds or gravel piles, may accidentally trigger the deployment of the frontal airbags.

Airbag System Failure Warning

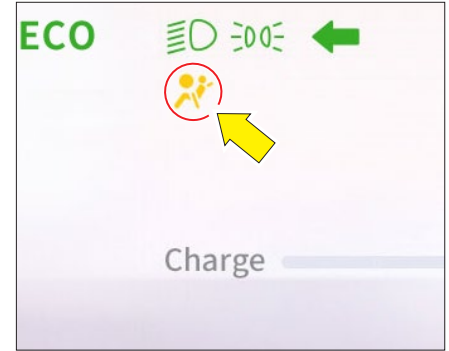

The airbag system failure warning light on the combination instrument panel is displayed as . It monitors the frontal airbags, airbag system failure warning light, and collision output signals, including diagnosing the frontal airbag module failure warning light, collision output signals, and all related circuits.

When the vehicle is powered on, the airbag system fault warning light will illuminate. If the system is functioning properly, this light will turn off after being lit for a period of time.

Supplementary Restraint System

In the following cases:

- The airbag system failure warning light remains illuminated after being lit for a period of time.
- The airbag system failure warning light intermittently flashes.
- The airbag system failure warning light does not illuminate at all.

These indicate that the Supplemental Restraint System (SRS), including the diagnosis of the frontal airbag module, failure warning light, collision output signals, and all related circuits, may have a fault and require repair or replacement. Please contact a dealership immediately.

Maintenance and Disposal of Airbags

The components of the airbag system are installed in various parts of the vehicle. Any work on the airbag system or the removal and installation of airbag system components due to the repair of other vehicle parts must be performed by professional technicians. Otherwise, the airbag system might be damaged, potentially causing abnormal triggering or failure to trigger in the event of an accident.

If the vehicle is scrapped, un-deployed airbags pose a potential hazard. Therefore, during vehicle scrapping, professional personnel must safely detonate the airbags.

WARNING

- Once inflated, airbags cannot be repaired and must be replaced with new airbag system components.
- If the front part of the vehicle is damaged in any way, please check the Supplemental Restraint System at a dealership.
- When handling scrapped airbag modules or the entire vehicle, do not attempt to do it yourself. Instead, have professionals use specialized equipment to detonate the airbag modules safely. Incorrect handling procedures may lead to personal injury.

Please visit a dealership for the following repairs to avoid incorrect maintenance work that could damage the Supplemental Restraint System (SRS) components or cause abnormal inflation of the airbags:

- Installation, removal, disassembly, and repair of the Supplemental Restraint System.
- Replacement or modification of the steering wheel, dashboard, sub-dashboard, and combination instrument.

Child Passenger Guidelines

To ensure the safety of child passengers, adult supervision is required. Choose an appropriate child restraint device based on the child's size. Incorrect use of child restraint devices can lead to serious or fatal injuries.

When purchasing a child restraint device, make sure to select one that is suitable for both the child and the vehicle.

To choose a child restraint device, place the child in the device and check various adjustments to confirm that it is suitable for the child.

Some types of child restraint devices may not be correctly installed in the vehicle. Install and use the child restraint device according to the manufacturer's instructions.

Child restraint devices should be installed on the sides of the rear seats. According to accident statistics, children are safer sitting in the rear seats than in the front.

Before installing a child restraint device, adjust the backrest of the rear seat and the position of the front seat to ensure enough space in the rear for the child restraint device.

After installing the child restraint device, check its fixation before placing the child in it. Move it from side to side and try pulling it forward to ensure it is securely fixed. The movement range of the child restraint device should not exceed a certain limit. If the restraint is not securely fixed, it must be tightened and checked again.

Always check the security of the child restraint device before placing a child in it.

Additionally, for larger children, there are many types of child restraint devices that should be used for maximum protection.

In hot weather, child restraint devices left in a closed vehicle can become very hot. Check the surface temperature of the device before placing a child in it.

WARNING

- Do not leave children alone in a vehicle.
- Do not let children sit in the front passenger seat, as the deployment of airbags can cause serious injury to children.
- Children weighing less than 13 kg must be seated in the rear of the vehicle using rear-facing child seats.

WARNING

- While the vehicle is moving, ensure that children maintain a proper sitting posture. Do not allow children to stand or kneel on the seats.
- When children are seated in the rear seats, activate the rear window lockout and child safety lock features.
- Do not allow children to extend parts of their body (like head, hands, etc.) outside the windows while the vehicle is moving.
- In addition to following the technical instructions in this manual, the installation and use of child seats must comply with local regulations. This manual's content is applicable in regions without specific regulations on child seat installation and use. In regions with specific regulations, if any content of this manual contradicts those regulations, the local regulations prevail.
- Failure to correctly install a child seat in the appropriate seat position can lead to insufficient protection for the child in the event of an accident, emergency braking, or sudden turns, potentially causing serious or even fatal injuries.

Child Passenger Safety

Child Seat Warning Labels

1
Safety

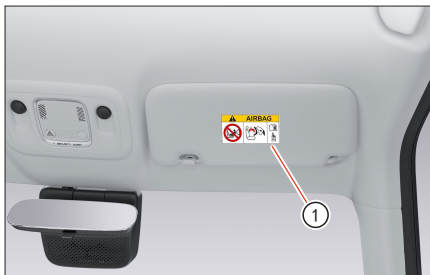

Warning instruction labels ① are located on the surface and inside of the front passenger sun visor.



Under no circumstances should a child seat facing the rear of the vehicle be placed on a front passenger seat equipped with an airbag, as this could result in severe injuries or fatalities.

For children aged 12 and under, the rear seat is the safest place. Always use seat belts and child seats simultaneously.

WARNING

It is strictly prohibited to install rear-facing child restraint devices on the front passenger seats. In an accident, rear-facing child restraints may be struck by deploying front airbags, leading to severe injury or death of the child.

Child Seat Fixation Devices



This vehicle is equipped with 2 sets of ISOFIX child seat fixation devices, each including 1 upper anchor bracket (1) and two lower anchor brackets (2).



The lower anchor brackets (2) are located at the connection between the rear seat backrest and the cushion, next to the "ISOFIX" label on the cushion. Opening the reserved socket will reveal the brackets.

The upper anchor bracket for safety seats is not visible inside the cabin and can be seen by flipping the rear seat or from the trunk.

Consult a dealership or the safety seat manufacturer if needed.

This vehicle accommodates various specifications of ISOFIX child seat devices. Install according to the manufacturer's instruction manual provided with the child seat.

⚠ WARNING

- The child seat fixation device is designed solely for installing child restraint devices. Under no circumstances should it be used to secure other items or equipment.

1

Safety

Child Passenger Safety

Selection of Child Seats

1 Seat Positions for Child Seats Fixed with Seat Belts

According to the regulations for "Motor Vehicle Child Passenger Restraint Systems", the table below shows options for using seat belts to fix child seats based on child weight and seat positions in the vehicle.

Seat Positions	Child Weight Group				
	Group 0 Less than 10kg	Group 0+ Less than 13kg	Group I From 9kg to 18kg	Group II From 15kg to 25kg	Group III From 22kg to 36kg
Front Passenger Seat	X	X	X	X	X
Rear Outer Seat	U ₂	U ₂	U	U	U
Rear Center Seat	X	X	X	X	X

Note: Meaning of letters and symbols in the table:

U: Suitable for installing "forward-facing" and/or "rear-facing" child seats fixed with seat belts.

U₂: Suitable for "rear-facing" child seats that are secured with seat belts.

U₁: Suitable for "forward-facing" child seats that are secured with seat belts.

X: Not suitable for installing child seats for the indicated child weight group.

Group 0/0+ Child Safety Seats



Suitable for infants weighing less than 13 kg.

Group I Child Safety Seats



Suitable for children weighing 9 kg to 18 kg.

Group II Child Safety Seat



Suitable for children weighing 15 kg to 25 kg.

Child Passenger Safety

Group III Child Safety Seat

1
Safety



Suitable for children weighing 22 kg to 36 kg.

Infants

Infants should use the correct child restraint devices when traveling in a vehicle. It is important to choose an appropriate child restraint device and install and use it according to the manufacturer's instructions.

WARNING

- Infants require special protection. The car's seat belts are not suitable for them, and an appropriate child restraint device should be used.
- Child seats can only be installed on the two side seats in the rear of the car.
- After installing the child restraint device, push and pull the child seat in different directions to ensure it is securely fixed.

Older Children

Older children can use the seat belt directly. If the upper part of the seat belt is too close to the child's face or neck, an auxiliary seat cushion (available in the market) that matches the vehicle seat should be used to improve this. The auxiliary seat cushion raises the child so that the upper part of the seat belt crosses the middle of the shoulder, and the lower part is positioned lower at the hips.

Children taller than 1.5 meters can use the existing seat belts in the vehicle directly, without needing a child seat.

WARNING

- Before the vehicle starts moving, it is essential to properly secure the child using an appropriate child restraint device. Otherwise, in the event of an accident or sudden braking, the child may suffer severe injuries.
- Do not allow children to leave the child restraint device and stand on the floor while the vehicle is moving.
- Do not allow children to leave the child restraint device and kneel on the seat while the vehicle is moving.

Compatibility Information for ISOFIX Child Seats

According to regulations, the table below lists the options for installing ISOFIX child seats on vehicle seats equipped with ISOFIX fixtures.

For universal and semi-universal ISOFIX child seats, the size category of the ISOFIX child seat is determined by letters A to G, which are marked in the ISOFIX identification on the child seat.

Seat Positions	Child Weight Group										
	Group 0 Less than 10kg			Group 0+ Less than 13kg			Group I From 9kg to 18kg				
ISOFIX Child Seat Types	Portable Crib		Rear-facing	Rear-facing			Rear-facing		Forward-facing		
ISOFIX Size Class	F	G	E	C	D	E	C	D	A	B	B1
	ISO/L1	ISO/L2	ISO/R1	ISO/R3	ISO/R2	ISO/R1	ISO/R3	ISO/R2	ISO/F3	ISO/F2	ISO/F2X
Front Passenger Seat	NoISOFIX										
Rear Outer Seat	X		IL-SU	IL-SU			IL-SU		IUF or IL-SU		
Rear Center Seat	NoISOFIX										

IUF : Suitable for installing universal "forward-facing" ISOFIX child seats secured with top tethers.

IL-SU: Suitable for installing semi-universal ISOFIX child seats in one of the following ways:

- "Rear-facing" child seats with top tethers or support legs;
- "Forward-facing" child seats with support legs;
- Baby carriers with top tethers or support legs.

X: Not suitable for installing child seats for the indicated child weight group.

Child Passenger Safety

Installing Child Seats with ISOFIX Anchorage Points

1
Safety

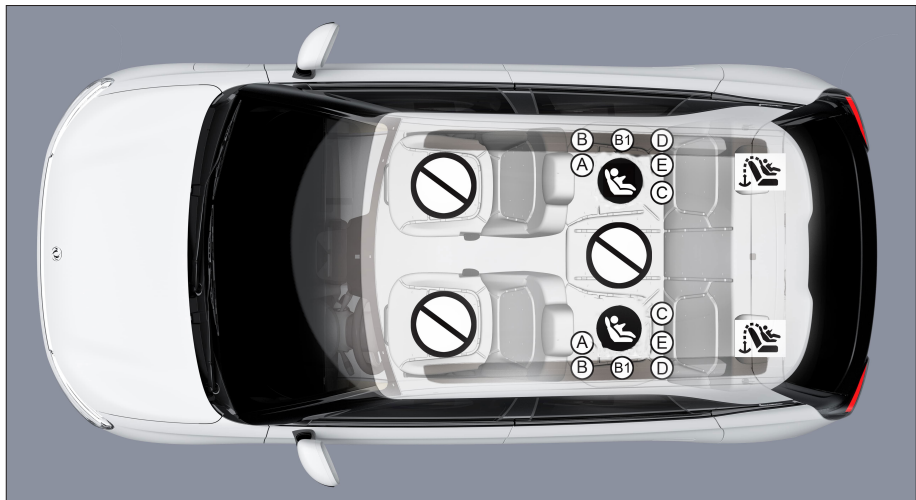

 Vehicle seats unsuitable for child seat installation.

 Vehicle seats allowing ISOFIX child seat installation.

 Rear seats with anchorage points, allowing the connection of universally approved forward-facing ISOFIX child seats. The anchorage points are located on the back of the rear seats.

The size of the ISOFIX child seat is indicated by letters:

- A, B, and B1: For Group I (9 to 18 kg) forward-facing seats;
- C and D: For Group 0+ (less than 13 kg) or Group I (9 to 18 kg) enveloping seats or rear-facing seats;
- E: For Group 0 (less than 10 kg) or Group 0+ (less than 13 kg) rear-facing enveloping seats;
- F and G: For Group 0 (less than 10 kg) portable baby beds.

 **CAUTION**

- Using unauthorized child seats poses serious risks, including fatal injuries.

Child Safety Lock

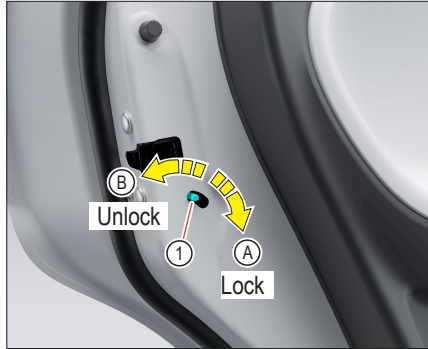

Activating the Child Safety Lock

Open the rear passenger side door, move the lever downwards (A) to ① activate the child safety lock. When activated, the door cannot be opened from inside the car, regardless of whether it is unlocked. To open the door, it must first be unlocked and then opened from the outside.

Deactivating the Child Safety Lock

Open the rear passenger side door, move the lever upwards (B) to ① deactivate the child safety lock.

CAUTION

- When children are seated in the rear of the car, the driver should activate the child safety locks and disable the passenger side window switches to prevent children from accidentally opening the rear doors or windows, which could lead to accidents.
- Never leave children or adults needing care alone in the car. They may inadvertently operate switches or controllers, leading to accidents.

Passenger Window Disable Switch



Press the switch ① to disable the function of all passenger window controls; however, the driver's side window switch can still operate to raise and lower the window.

Press the switch ① again to deactivate the disable function.

CAUTION

When children are passengers in the rear, the driver is advised to activate the passenger window lock function to prevent children from operating the window raising and lowering mechanism.

2. Before Driving

Pre-Drive Checks	46	Closing the Trunk Door	59	Rearview Mirror Adjustment	75
Inspection Items	46	Charging Port	60	External Rearview Mirror	75
Correct Seating Position for the Driver ...	46	Opening the Charging Port Cover	60	Internal Rearview Mirror	77
Correct Seating Position for Front Passenger	47	Closing the Charging Port Cover	60	Lighting	78
Correct Seating Position for Rear Passengers	48	Vehicle Charging	61	Light Locations	78
Vehicle Key	49	Charging Precautions	61	External Lights	80
Smart Key	49	Home AC Charging Method	65	Response Reflector	84
Mechanical Key	55	AC Charging at Charging Stations	66	Interior Lighting	84
Frameless Car Doors	56	Emergency Unlock of AC Charger	66	Windshield Wipers and Washer	86
Retractable Door Handles	56	DC Charging at Charging Stations (Fast Charging)	66	Windshield Wipers and Washer	86
Automatic Minor Adjustment of Car Windows	57	Charge Energy Management	67	Electric Windows	88
Door Ajar Warning	57	Vehicle Charging	68	Master Window Control for Driver's Side	88
Interior Door Handles	57	Discharging Methods*	68	Passenger Window Controls	89
Central Control Door Lock	58	Discharge Trouble Diagnosis	69	Remote Control for Windows	89
Central Control Door Lock Button	58	Discharge Energy Management	69	Windows Auto-Up on Lock*	89
Auto Door Locking When Driving	58	Seat Adjustment	70	Delayed Power Supply for Windows	90
Collision Unlock	58	Introduction to Seats	70	Anti-Pinch Windows	90
Auto Relock	58	Front Seat	70	Window Initialization	90
Trunk Door	59	Steering Wheel Adjustment	74		
Opening the Trunk Door	59	Rear Seat	74		
		Steering Wheel Position Adjustment	74		

Pre-Drive Checks

Inspection Items

For driving safety, please ensure to carry out the following checks before driving:

- Confirm the surrounding environment and tire conditions.
- Seat and headrest positions.
- Brake pedal condition.
- Seatbelt condition.
- Steering wheel position.
- Internal and external rearview mirror angles.
- Lighting illumination and adjustment functions.
- Windshield wipers and washer functions.
- Remaining driving range.

CAUTION

If installing floor mats, please adhere to the following cautions:

- Do not use multiple floor mats overlapped.
- Do not use floor mats that are not matched to this vehicle model.

Correct Seating Position for the Driver



The correct seating position for the driver can reduce driving fatigue and ensure vehicle safety.

For the safety of occupants, the driver should perform the following operations before driving:

1. Sit fully in the seat, keeping the back and shoulders against the seatback. Adjust the seat height for a good field of vision.
2. Move the seat forward or backward to a suitable position, so that with slightly bent knees, you can fully press the accelerator

and brake pedals.

3. Maintain at least 10cm distance between the knees and the dashboard.
4. Adjust the backrest to an appropriate angle, so that the back is fully against the backrest, and the angle of the backrest should not exceed 25° from the vertical.
5. Adjust the headrest height so that its upper edge is level with the top of your head.
6. Adjust the steering wheel at least 25cm away from the chest, with the arms naturally bent to hold the steering wheel. Ensure that the elbows are slightly bent to hold the top of the steering wheel.
7. Adjust rearview mirrors to the appropriate positions.
8. Properly wear the seatbelt.

WARNING

- To reduce the risk of injury in accidents, the distance between the steering wheel and the driver's chest should not be too close, otherwise, the airbag cannot provide effective protection and may cause harm to the driver.
- The driver's hands should always be on the outer circle of the steering wheel (at 9 and 3 o'clock positions) to ensure visibility of all the gauges and indicator lights on the combination instrument panel.

⚠ WARNING

- During driving, the seatback should not be reclined excessively, and the seatbelt must be worn correctly to maintain the proper posture, to avoid injury in case of emergency braking.
- Do not adjust the seat while driving. If necessary, adjust the seat to the correct position after stopping the vehicle, then resume driving.
- Children adjusting the seat might get injured, especially when unattended, posing a risk of harm.

Correct Seating Position for Front Passenger

For riding safety, front passengers should perform the following operations:

1. Adjust the seat to maintain enough distance between the front passenger and the dashboard, so that the airbag can provide the most effective protection when deployed.
2. Sit fully in the seat, keeping the back and shoulders against the seatback, and adjust the headrest height so that its upper edge is level with the head.
3. Properly wear the seatbelt.
4. Keep both feet in the foot space in front of the front passenger seat.

👁 CAUTION

- During driving, keep the correct sitting position and do not place feet on the dashboard or coil them on the seat, and do not protrude any body part out of the window. Otherwise, you are at a high risk of injury in case of emergency braking or accidents.
- If the front passenger is too close to the dashboard, the airbag system will not be able to provide effective protection.

⚠ WARNING

- To reduce the risk of injury in accidents, the front passenger should not be too close to the dashboard, otherwise, the airbag will not be able to provide effective protection and may even cause harm.
- Do not place feet on the dashboard or the window, and do not sit cross-legged on the seat while the vehicle is in motion, as this can lead to serious injury in case of emergency braking or accidents.

WARNING

- During driving, the seatback should not be reclined excessively, and the seatbelt must be worn correctly to maintain the proper posture, to avoid injury in case of emergency braking or accidents.

Correct Seating Position for Rear Passengers

For riding safety, rear passengers should perform the following operations:

1. Maintain an upright sitting posture, keeping the back as close to the seatback as possible.
2. Place both feet in the foot space in front of the rear seats, firmly on the floor.
3. Properly wear the seatbelt.
4. When carrying children, appropriate safety measures must be taken in accordance with relevant regulations.

Smart Key

Composition of the Smart Key

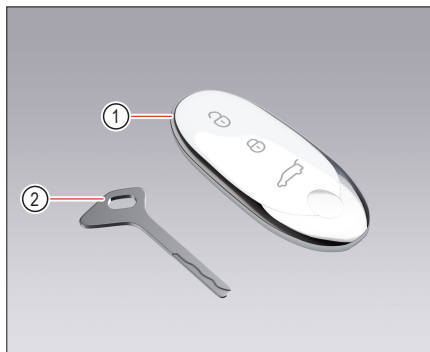

- ① Smart Key
- ② Mechanical Key



Each vehicle is equipped with a smart key and a mechanical key.

Only the smart key that matches the vehicle can unlock the doors and start the vehicle.

If the key is lost, please contact the dealership immediately.

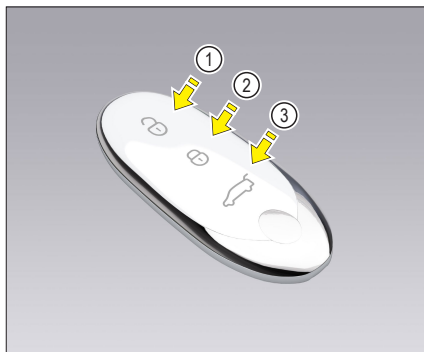
Smart Key Remote Control Functions



- ①  Vehicle Unlock Button
- ②  Vehicle Lock Button
- ③  Rear Door Unlock Button

CAUTION

The smart key is a sensitive control device. Do not fiddle with it carelessly to avoid unintentionally unlocking the doors or causing malfunction.

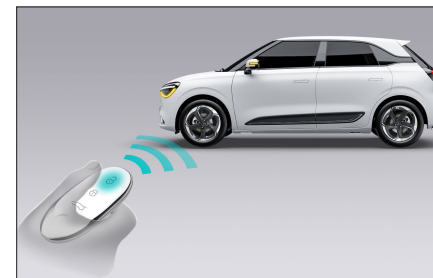

Remote Unlocking of Vehicle

1. Press the unlock button  ;
2. All turn signals blink twice;
3. The vehicle is unlocked;
4. Hidden door handles automatically extend*;
5. Pull the exterior door handle or press the rear door latch handle's internal request switch to open the doors or rear door.

After remotely unlocking the vehicle, if no door (including the rear door) is opened within 30s, the vehicle will automatically relock.

Vehicle Key

Remote Locking of Vehicle

1. Close all doors (including the rear door);
2. Press the lock button  ;
3. The horn will sound once;
4. All turn signal lights illuminate for a period of time before turning off.
5. The vehicle is locked;
6. Hidden door handles automatically retract*, confirming locking.

Remote Unlocking of the Rear Door

1. Press and hold the rear door unlock button  ;
2. All turn signal lights illuminate for a period of time before turning off.
3. The rear door is unlocked;
4. Press the request switch inside the trunk door handle and lift upwards to open the trunk door.

Remote Car Search

Within the remote control range, quickly press the lock button  twice to activate the car-finding feature. The hazard warning lights will flash, accompanied by two horn beeps, facilitating quick vehicle location.

Remote Convenience Auto Window Opening

Hold down the unlock button  to automatically lower the windows until fully open, providing ventilation for the vehicle in advance.

i NOTE

If the button is released during the automatic window opening process, the windows will not stop lowering.

Remote Convenience Auto Window Closing

After locking the vehicle, if you notice that the windows are not fully closed, holding down the lock button  will automatically raise the windows.

i NOTE

If the button is released during the automatic window closing process, the windows will not stop closing.

⚠ WARNING

During the automatic window closing process, ensure no part of anyone's body is in the closing area of the windows to prevent injury.

Situations Where Remote Control Cannot Be Used

The effective range of the remote control function depends on the surrounding environment. The remote control may not work in the following situations:

- The smart key is not within the working area (e.g., when there are many obstacles around).
- Doors (including the rear door) are open or not properly closed.
- The battery of the smart key is exhausted.

👁 CAUTION

The remote control functions of the remote device may be affected by electronic accessories added to the vehicle, such as an in-car GPS. Please have a technician from an authorized dealer handle the installation of any electronic accessories.

Keyless Entry Feature*

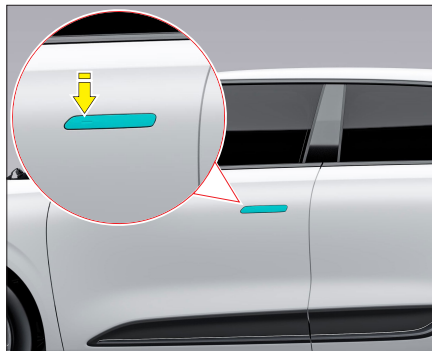

Keyless Unlocking of Car Doors

1. Carry the smart key within its effective range.
2. Touch the recessed area on the door handle once to request opening;
3. All turn signals blink twice;
4. All doors are unlocked, and hidden door handles automatically extend*;
5. Pull the exterior door handle or press the rear door latch handle's internal request switch to open the doors or rear door.

Keyless Locking of Car Doors

1. Carry the smart key within its effective range.
2. Close all doors (including the rear door);
3. Touch the recessed area on the door handle once, all turn signals blink once;
4. Hidden door handles automatically retract*, confirming locking.

i NOTE

After keyless unlocking of the doors, you must open any door within 30s; otherwise, the doors will automatically relock.

Keyless Opening of the Rear Door



1. Carry the smart key within its effective range.
2. Press the request switch inside the trunk door handle and lift upwards to open the trunk door.

Vehicle Key

2

Before Driving

Auto Unlock Feature When Approaching the Vehicle*



When the auto unlock feature when approaching the vehicle is enabled, carry the key and approach the vehicle (around 1.5m near the left front door handle or rear door), the doors will automatically unlock, hidden door handles automatically extend*, and all turn signals blink twice.

You can set the auto unlock feature when approaching the vehicle to be enabled/disabled in the MP5 vehicle settings → Door Lock Window interface.

i NOTE

If not approaching the left side door handle or rear door, even if carrying the key, it will not automatically unlock.

Auto Lock Feature When Leaving the Vehicle*

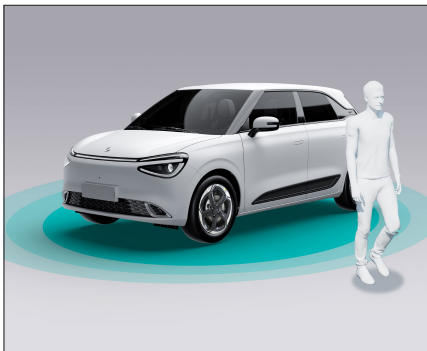

When the auto lock feature when leaving the vehicle is enabled, with the gear in P position, all doors (including the rear door) closed, carrying the key, and moving away from the vehicle (about 3m perpendicular to the left side door handle or rear door), the doors will automatically lock, hidden door handles automatically retract*, and all turn signals blink once.

You can set the auto lock feature when leaving the vehicle to be enabled/disabled in the MP5 vehicle settings → Door Lock Window interface.

i NOTE

- Please take your keys with you when you leave the car and do not leave them in the car, or you may be alerted by the horn.
- If not moving away perpendicular to the left side door handle or rear door, it will not automatically lock.

Vehicle Start Function

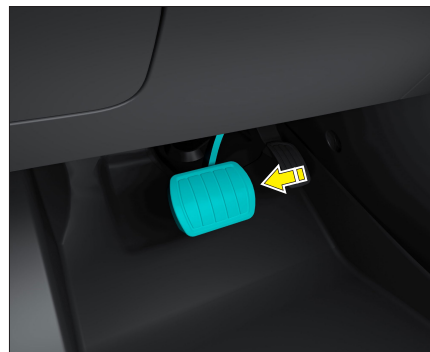

Carry the smart key, unlock and enter the vehicle, step on the brake pedal, the vehicle starts and enters READY status, and the READY indicator light on the combination instrument panel lights up.

Replacing the Key Battery

The battery life depends on the frequency of operations and the surrounding environment. Under normal usage conditions, the battery's lifespan is about 2 years. The remote control function on the key fob may not operate properly within a short range if the battery is depleted or nearly depleted. Please replace the battery as soon as possible.

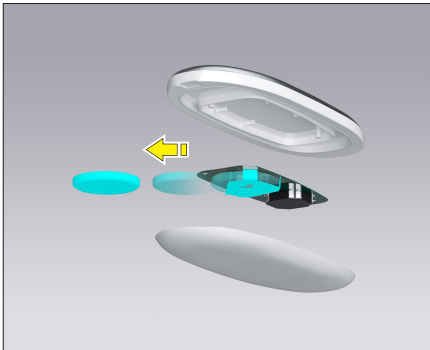

It is recommended to replace the remote control key battery at an authorized dealer, or under the guidance of a professional to avoid damaging the remote control key.

If replacing it yourself, prepare a CR2032 battery and the corresponding tools.

Environmental Notice



The battery contains pollutants. It is illegal to dispose of the battery with household waste. Batteries must be collected separately and recycled in an environmentally friendly manner.



Please dispose of the battery in an environmentally friendly manner. Bring depleted batteries to an authorized dealer or a dedicated waste battery collection point.

CAUTION

- Avoid touching the internal circuit and electronic contacts, as this may cause a malfunction.
- Do not use metal tweezers to hold the positive and negative terminals of the battery to avoid severe depletion of the battery.
- Be careful not to let children swallow the battery and disassembled parts.
- Improper disposal of waste batteries will harm the environment, please dispose of them in accordance with relevant laws and regulations.

CAUTION

- When the smart key is within operational range, anyone (including those without a smart key) can touch the request switch to lock/unlock the doors or open the rear trunk door.
- The radio waves emitted by the smart key may adversely affect electronic medical equipment. For example, patients with pacemakers should contact the hospital or the manufacturer of the electronic medical device before using or approaching the smart key to inquire if it will be affected.
- Do not change the transmission frequency or increase the transmission power on your own, do not externally connect an antenna or use other transmission antennas.
- If using the smart key causes harmful interference to legitimate radio communication services, stop using it immediately and contact the dealership.
- Do not use the smart key on airplanes or in places where the use of radio devices is expressly prohibited.

CAUTION

- If you lose the key, contact an authorized dealer immediately.
- Do not leave the smart key in the vehicle when leaving.
- The smart key contains electronic components; do not let it get wet, as it may cause damage to the key and affect system functionality.
- Do not use the smart key to knock on other objects.
- Do not leave the smart key in places where the temperature exceeds 60°C for a long time.
- Do not hang the smart key on a key holder that contains magnets.
- Do not place the smart key near devices that can generate magnetic fields, such as audio equipment or wireless phone chargers.
- Do not place the smart key near electronic products, such as mobile phones, laptops, etc., to avoid interference.

CAUTION

- Do not place the smart key in the following locations inside the vehicle to prevent it from being locked inside:
- When placed on the dashboard or inside the glove compartment;
 - When placed on the rear parcel shelf;
 - When placed inside the door storage box or cup holder;
 - When placed in the corners of the trunk or under the onboard tools;
 - When placed inside or near metal materials.

Mechanical Key

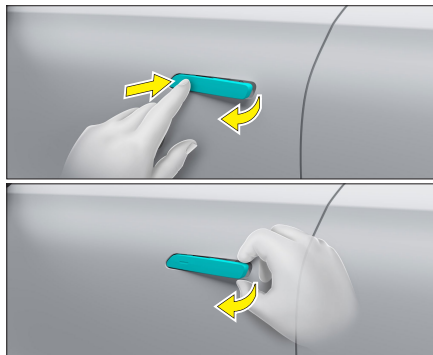

Use the mechanical key to unlock/lock the doors when the vehicle is low on power or the smart key is out of power:

Unlocking/Locking the Driver's Door

1. Press the front end of the hidden handle on the driver's side to make the handle pop up;
2. Pull out the hidden handle to fully extend it, revealing the keyhole;
3. Insert the mechanical key into the keyhole;

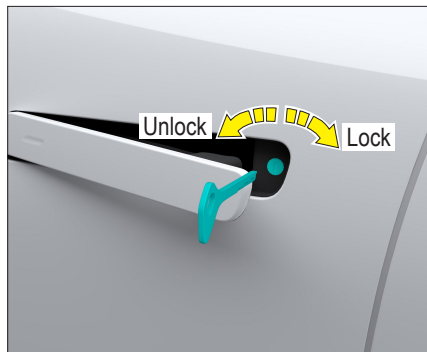

4. Turn the mechanical key toward the front/rear of the vehicle to unlock/lock the door.

Locking Other Doors

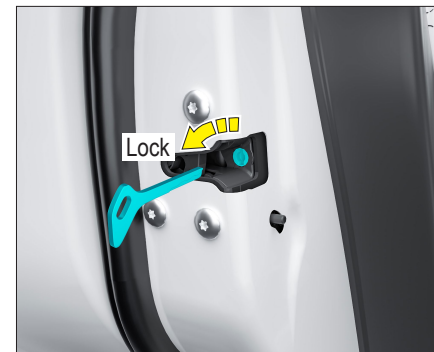

1. Open the door, each door has an emergency lock switch, insert the mechanical key into the switch;
2. For the left doors, turn counterclockwise to lock;
3. For the right doors, turn clockwise to lock.

Frameless Car Doors

Retractable Door Handles



2

Before Driving

The vehicle is equipped with retractable door handles to reduce aerodynamic drag, providing a better driving experience.

- When the vehicle is unlocked, the retractable door handles automatically extend*; pull the handle to open the door.
- When the vehicle is locked, the retractable

i NOTE

If the 12V battery is depleted, the retractable door handles will not automatically extend when unlocking the vehicle. Manually press and lift the handle to pull it out.

door handles automatically retract* and go into a hidden position.

⚠ WARNING

- When locking the car, the retractable door handles will electrically retract. Please be cautious to avoid pinching your fingers.
- After manual operation, the handles will mechanically retract. Please be cautious to avoid injury.

⚠ CAUTION

- The retractable door handle system may fail to pop out normally in case of malfunction or freezing.
- In winter, after washing the car in the north, dry the water in the gaps around the retractable door handles to prevent freezing, which could prevent the handles from electrically extending.
- In cold weather, avoid spraying water directly at gaps like door handles or door locks, as they may freeze and become inoperable.
- At a certain driving speed, the retractable door handles automatically retract to reduce aerodynamic drag and enhance your driving experience.

Emergency Extension of Retractable Door Handles

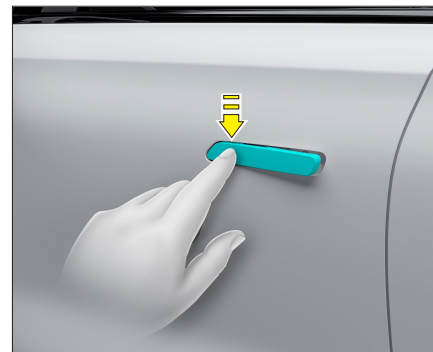

In cases where the electric retractable door handles are frozen by snow or jammed with foreign objects and cannot extend after unlocking the vehicle, use the following emergency procedure:

- Press forcefully on the leftmost side of the handle, causing the right side to pop out;
- Pull the handle to try opening the door;
- Once the handle can move freely, open and close it several times to remove any remaining ice;
- Unlock/lock the vehicle to ensure the retractable door handles extend/fold normally.

Automatic Minor Adjustment of Car Windows

- When opening the car door, the corresponding side window automatically lowers slightly to facilitate door opening.
- After closing the door, the corresponding side window immediately rises to a fully closed position.

CAUTION

If the door is closed and the window is not in the position it was when last opened, the window will not automatically raise.

Collision-Induced Minor Window Lowering

In the event of a collision, the windows of all four doors may lower slightly to facilitate rescue operations.

Door Ajar Warning

If any door is not fully closed when the vehicle reaches a certain speed, the vehicle will issue a warning message and sound, urging you to close the door promptly.

CAUTION

If any door (including the trunk door) is ajar, using the central control door lock button to lock the car will fail. You will hear one locking sound, followed by a rebound unlocking sound as a prompt. Identify the cause of the failed locking and address it, then lock the vehicle again.

Interior Door Handles

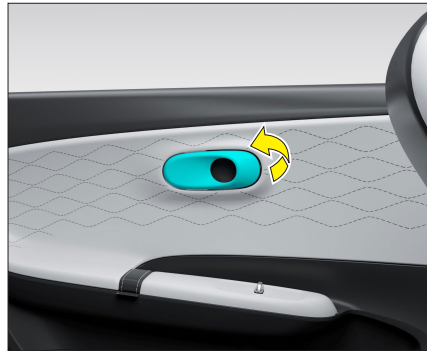

When the car door is locked, you need to pull the interior door handle once to unlock that door, and then pull it again to open the door. This prevents the accidental opening of the door while driving.

CAUTION

- Do not pull the interior door handle while the vehicle is in motion, as this may inadvertently open the door and pose a danger. If children are seated in the back, use the child safety lock to prevent accidental opening of the rear doors.
- When the door is locked, do not force the interior door handle to push open the door, as this may cause damage to the handle. Pull the handle twice to open the door.
- When parking on the roadside, after the vehicle has stopped, the driver should check the rearview mirror to ensure no pedestrians or incoming traffic is approaching before opening the door or instructing passengers to exit. (It's recommended that rear passengers do not open the left door.)
- Before opening the door to exit (especially from the left side), check behind, open a small gap in the door to confirm it's safe, then exit.
- If the rear door cannot be opened from inside, it may be due to the child safety lock being engaged. Do not forcefully pull the interior door handle, which may cause damage. Unlock the vehicle from the outside to open the door.

Central Control Door Lock

Central Control Door Lock Button



2

Before Driving

- When the vehicle is locked, press the central control door lock button to unlock the vehicle.
- When the vehicle is unlocked, press the central control door lock button to lock the vehicle.

👁 CAUTION

If any door or the trunk door is not fully closed, the doors cannot be locked. In this case, the doors first attempt to lock and then unlock once.

Auto Door Locking When Driving

When the automatic locking feature is activated, all doors automatically lock once the vehicle speed reaches approximately 10 km/h or higher.

Automatic Locking Switch

Models Without MP5: Long press the central control door lock button to turn the automatic

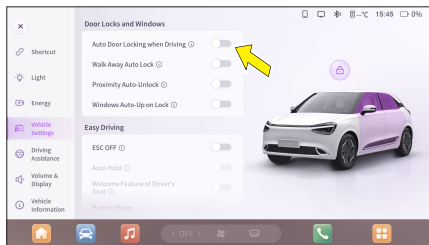

locking feature on/off;

Models With MP5: Activate/deactivate the automatic locking feature in the vehicle settings → door lock and window interface.

👁 CAUTION

If you manually unlock the doors after they have automatically locked, to retrigger the automatic locking, the vehicle speed must drop below 10 km/h and then exceed it again for the doors to automatically lock.

⚠ WARNING

Driver's Responsibilities: If you decide to keep the doors locked while driving, remember that in emergency situations, it may become more difficult for rescue personnel to gain access to the interior of the vehicle.

Collision Unlock

If the vehicle is involved in a collision that causes the airbags to deploy, the doors will automatically unlock, hazard lights may automatically turn on, and all locking functions are disabled at this time.

Auto Relock

After locking the vehicle and accidentally unlocking it, if the doors or the trunk door are not opened within 30 seconds, the vehicle will automatically relock itself.

👁 CAUTION

Even if the vehicle has a feature to prevent accidental unlocking, do not play with the keys after locking the vehicle. Ensure that the vehicle remains locked to avoid accidental unlocking and unnecessary losses.



Opening the Trunk Door



Keyless Opening

1. Carry the smart key within its effective range.
2. Press the request switch inside the trunk door handle and lift upwards to open the trunk door.

Remote Control Opening

1. Press the unlock button  on the remote control, or press and hold the tailgate unlock button .
2. Press the request switch inside the trunk door handle and lift upwards to open the trunk door.

 CAUTION

- The 12V battery must have power for the remote key to unlock the door.
- After opening the trunk door, push it upwards to its maximum opening angle and ensure it's stable before loading or unloading items for safety.

Closing the Trunk Door



1. Check that there are no obstacles or body parts in the area where the trunk door will close.
2. If there is a lot of luggage, gently try closing the trunk door first, ensuring that no luggage is obstructing it, then proceed to close the door.
3. Grasp the handle on the right side of the trunk door, pull it down, and press the door until it locks securely.

 CAUTION

Be cautious not to have the trunk door obstructed by luggage when closing.

Charging Port

Opening the Charging Port Cover

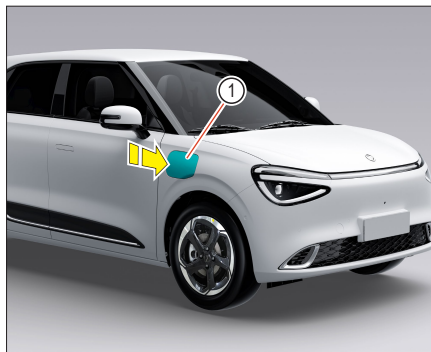

Charging Port Cover ① is located on the right fender panel.

Press the rear part of the Charging Port Cover ①, and the cover will spring open.

AC and DC Charging Ports

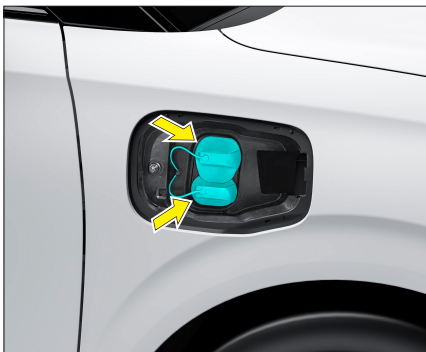

Remove the dust cover to reveal the charging ports.

- The AC charging port is located on the top.
- The DC charging port is located at the bottom. (The AC charging port dust cover must be removed before the DC charging port dust cover can be detached.)

Closing the Charging Port Cover

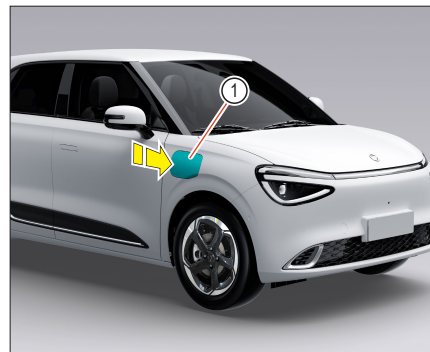

1. Replace the dust cover of the charging port.
2. Press the rear part of charging port cover ① to close the charging port cover.

2

Before Driving

Charging Precautions

⚠ CAUTION

- When the battery indicator turns red, it indicates that the power battery is low. Please charge it as soon as possible to avoid the vehicle being unable to drive due to insufficient battery.
- For long-distance travel, ensure that the State of Charge (SOC) is above 50% before using the vehicle.
- The optimal storage temperature for the power battery should be maintained between 20°C and 35°C.
- The humidity of the power battery storage environment should be kept between 30% and 70%.
- The vehicle should be parked and charged in a dry and ventilated environment, away from direct sunlight, flammable and explosive materials, and heat sources.
- When the vehicle is parked for an extended period, the optimal SOC range for battery storage is 50% to 70%. Additionally, charge the battery slowly to full once every three months, then discharge it to an SOC of 50% to 70% before parking again.
- If the vehicle is parked for a long time without charging as required, it may cause excessive battery discharge, thereby reducing the performance of the power battery. Dongfeng will not assume any related responsibilities for vehicle malfunctions and damage caused by this, including quality guarantees.

⚠ CAUTION

- Once the charging gun is connected to the vehicle's charging port, the vehicle will not start.
- Do not stay inside the vehicle during charging.
- Park the vehicle in a ventilated area during charging.

⚠ WARNING

- Choose a safe environment (damp-proof, high-temperature-proof) for charging.
- Do not modify or dismantle the charging port or charging equipment, as this may cause charging failures or even fires.
- Before charging, ensure that there is no water or foreign objects in the vehicle charging port and charging gun, and that the metal terminals are not rusted or corroded. If these conditions are present, do not proceed with charging operations. As abnormal terminal connections can cause short circuits or electric shocks, endangering life.
- If an abnormal smell or smoke is detected during charging, immediately stop charging and contact the dealership.

⚠ WARNING

- To avoid personal injury, be aware of the following while the vehicle is charging:
 - Do not touch the charging port on the car or the metal terminals inside the charging gun;
 - Do not charge the vehicle or touch it during thunderstorms, as lightning strikes may damage the vehicle's charging device and cause personal injury.
- After charging, do not unplug the charging gun with wet hands or while standing in a wet area, as this may cause electric shock and injury.
- If you need to use electronic medical equipment inside the car, confirm with the manufacturer whether charging an electric car affects the normal operation of the medical device. Avoid charging that may cause the medical device to malfunction, leading to personal injury.
- If you have a device such as a pacemaker implanted in your body, check with the manufacturer to make sure that driving a new energy vehicle does not interfere with the proper functioning of the pacemaker, so as not to cause personal injury.

CAUTION

- Avoid turning on the air conditioning while the vehicle is charging, as this can accelerate the power battery's wear and prevent full charging.
- When charging at a charging station, leave the vehicle and strictly follow the station's charging instructions. Stay outside the safety line due to high voltage danger.
- The system will automatically stop charging when the power battery is fully charged.
- Before starting the vehicle, ensure that the charging port cover and dust cover are closed. An open charging port cover can allow water or foreign objects to enter, affecting normal use.
- When the ambient temperature is below 0°C, charging efficiency decreases, so charging takes longer than usual.
- When fast charging the vehicle, to minimize wear on the power battery, charging from 0% to 30% and 80% to 100% will take longer.

CAUTION









- Frequent use of rapid charging methods can have a negative impact on the power battery. To extend the service life of the power battery, it is advised to avoid using rapid charging methods for extended periods.
- To avoid damaging the charging equipment, be aware of the following:
 - Do not close the charging port cover while the dust cover is open;
 - Do not forcefully pull or twist the charging cable;
 - Do not hit the charging equipment;
 - Do not let the charging cable near heaters or other heat sources.
 - During AC charging, the charging gun will be locked. Do not forcefully pull the charging gun to avoid damaging the interface.
- Do not perform AC and DC charging simultaneously!

NOTE

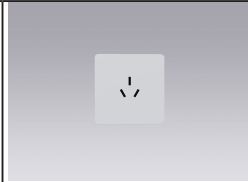
- The time required to fully charge the power battery depends on the charging method, the remaining power battery level, real-time temperature, usage time, external temperature, and the charging power source's output power. The actual charging time may differ from the data provided in this manual.

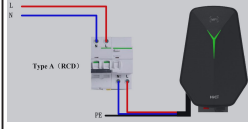
This vehicle is a new energy vehicle that operates solely on power from the battery. When the battery indicator on the instrument panel turns red, the vehicle should be charged. Although the vehicle can travel a certain distance when the battery is low, frequently deep discharging the battery will shorten the power battery's lifespan. Charge in time and fully consider the journey and charging stations en route to avoid being stranded due to insufficient battery.

The charging port is located on the right fender: the upper port is for alternating current (AC) charging; the lower port is for direct current (DC) charging. There are various charging methods, and users can choose the best charging method according to different environments. (The actual charging time required depends on the charging method, the remaining power battery level, real-time temperature, usage time, external temperature, etc., and may differ from the data given in this manual)

Charging Mode	Charging Port	Charging Cable Charging Gun	Power supply	Charging Instructions	Charging time
Mode 1: Home AC charging ($\leq 16A$)				Charging at home with a dedicated socket	Charging time from 10% to 100% SOC is approximately 9~10 or 13~14 hours or more (ambient temperature around 25°C)
Mode 2: AC Charging at Charging Stations ($\leq 32A$)				Does not support 42kW power 63A three-phase AC charging pile	Charging time from 10% to 100% SOC is approximately 9~10 or 6~7 hours or more (ambient temperature around 25°C)
Mode 3: DC charging at charging stations (fast charging)				Fast charging at public charging stations (emergency charging method, not recommended for long-term use)	Charging time from 10% to 80% SOC is about 45 minutes or more (ambient temperature around 25°C)

CAUTION

- Charging time depends on the remaining battery level, the output power of the charging terminal, and the ambient temperature.
- When the ambient temperature is below -20°C or above 55°C, the vehicle cannot be charged.
- To maintain the power battery's lifespan, avoid frequently driving with low battery and charge in time.
- When the vehicle is parked for an extended period, the optimal SOC range for battery storage is 50% to 70%. Additionally, charge the battery slowly to full once every three months, then discharge it to an SOC of 50% to 70% before parking again.
- If the vehicle is stored for a long period without charging maintenance, it may result in battery damage. Dongfeng will not assume any related responsibilities for vehicle malfunctions and damages arising from this, including quality guarantees. Charging frequency and cycle are recorded by the battery management system.

WARNING

- Do not wash the vehicle during charging;
- Do not wash the charging cable during charging;
- Do not clean the charging cable connectors and plugs to prevent terminal corrosion.
- Do not use extension cords when the charging distance is insufficient, as there is a risk of fire.
- Do not use a 10A to 16A adapter, as there is a risk of fire.

WARNING

- When installing a domestic charging socket or charging pile, the length of the cable connecting the air switch to the charging socket or charging pile should not exceed 1m, to avoid fire risks.
- Do not use undersized charging cables and sockets, as they may overheat due to the high charging current, leading to a fire.
- When using a domestic charging socket, do not place the charging socket on the vehicle, and do not add an extension board between the charging socket and the charging cable connector, as this can lead to a fire.

Home AC Charging Method

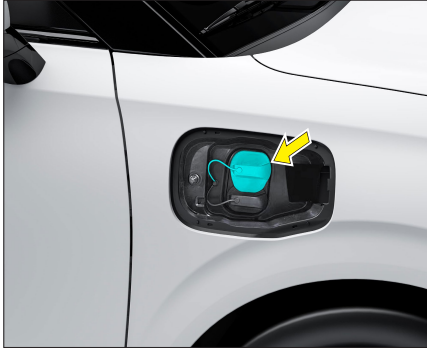

1. Shift the gear to the "P" position;
2. Close all doors (including the rear door);
3. Open the charging port cover;
4. Remove the dust cover from the AC charging port above;
5. Connect the charging cable plug to a power socket, check and confirm the charging cable control box power indicator light is steady green;

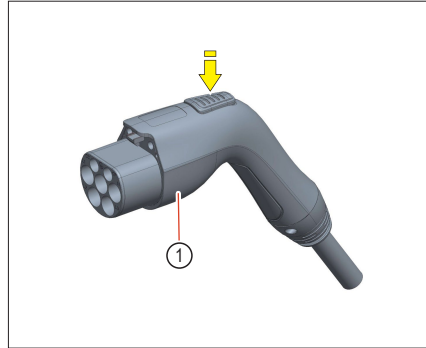

6. Align the charging gun and fully insert it into the AC charging port to match the charging gun with the charging base. Confirm that the charging gun is locked;

⚠ WARNING

- Use only a dedicated socket (with leakage protection device, air switch, grounding, etc.) to charge the vehicle, and avoid sharing the line with other household appliances to prevent electric shock.
7. When charging starts, the combination instrument panel will display the remaining battery percentage and the time needed to complete charging;
 8. The "charging cable connection indicator light"  on the instrument cluster lights up;
 9. After charging is complete, first unlock the vehicle (even if the doors are not locked), then press the release button ① on the charging gun to remove it, and finally disconnect the power.
 10. Close the charging port dust cover.
 11. Close the charging port cover.

Vehicle Charging

CAUTION

- The charging gun will be locked when the charging cable gun is connected to the vehicle's charging port.
- The charging gun cannot be removed if the vehicle is not unlocked. If the gun cannot be removed after unlocking the vehicle, use emergency unlocking or contact the dealership.
- Before closing the charging port cover, ensure the charging port dust cover is closed.
- If installing a 16A domestic socket, it must be installed by a qualified electrician with an air switch, and the socket must meet local regulatory standards.
- When charging with charging cable, check whether the household wall socket meets the local regulatory standards. If not, do not use this socket.

AC Charging at Charging Stations

The method for charging at AC charging stations is similar to home AC charging.

CAUTION

- The AC charging connector cannot be detached if the vehicle is locked.
- Before closing the charging port cover, ensure the charging port dust cover is closed.

Emergency Unlock of AC Charger

If the AC charger fails to unlock normally, use the emergency unlock pull cord located on the right side of the front compartment:

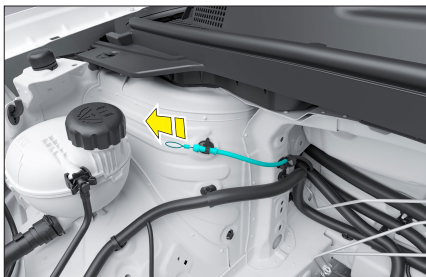



DC Charging at Charging Stations (Fast Charging)



Follow these steps for charging:

1. Shift the gear to the "P" position;
2. Close all doors (including the rear door);
3. Open the charging port cover;
4. Remove the dust cover from the AC charging port above and the DC charging port below;
5. Set the charging service based on desired charge amount, time, and cost;



6. The dashboard's "charging cable connection indicator light"  will illuminate when charging begins;
7. Once charging is complete, unplug the charger, close the charging port cover and cap, and the "charging cable connection indicator light"  will turn off.

Charge Energy Management

In MP5's "Energy" interface, you can view and manage charging details.

Tap on "Charging" to access charging settings:

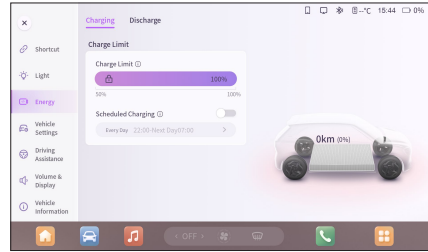

- The MP5 Energy → Charging interface displays vehicle status (charging status, driving range, battery level, charging power, current, voltage, and charger connection status).

- Options to set charging limits, schedule charging, unlock slow charging gun, and terminate charging are available.
- For scheduled charging, if the charger is connected but it's not the set charging time, tap "Start Charging" to charge immediately.
- Tap "End Charging" during charging to stop the process.

iNOTE

Scheduled charging is exclusive to users of dedicated charging poles.

Vehicle Charging

Discharging Methods*

Using a self-purchased power strip discharge connector to achieve external vehicle discharge, the maximum external discharge power is 3.3kW.

Vehicle to Power Strip Discharge Connection Device: A charged vehicle can use a power strip to supply electricity for charging devices such as mobile phones, computers, etc.

CAUTION

- When the vehicle's external discharge reaches the discharge limit, it will stop discharging.
- It is recommended to unplug the device when not in use to avoid high static power consumption.
- Before using the vehicle's external discharging function, the high-voltage system of the vehicle needs to be checked, which may affect the discharge response time.
- Before using the vehicle's external discharge function, confirm that the external appliance's power is less than 3.3 kW. For some appliances with higher starting power (such as air conditioners), the starting process may trigger the vehicle's discharge function's over-power protection, resulting in abnormal discharge function.

NOTE

- Please use this function when the power battery capacity is sufficient.

Pre-Discharge Check

Please purchase a power strip discharge connection device on your own and ensure that the discharging device is free from scratches, rust, cracks, or damage to the gun, cable, socket, and the surface of the wires.

Do not discharge if the socket surface is damaged, rusted, cracked, or the connection is too loose.

When the plug is dirty or damp, disconnect the power first and wipe the plug with a dry clean cloth to ensure that the discharge plug is dry and clean.

Activating Discharge Function



1. Before discharging, ensure that there are no faults in the high voltage of the vehicle, and switch the vehicle power to "ON" mode;
2. Unlock the vehicle, press the rear part of the charging port cover, and open the cover;
3. Remove the dust cover from the AC charging port;
4. Press the release button on the discharge cable connector, remove the protective cover;
5. Insert the discharge plug into the vehicle's discharge socket until a click is heard;
6. Press the switch on the discharge socket and wait a few seconds, then the socket indicator light stays on (red), indicating the socket is ready for use.

CAUTION

- To prevent malfunction of the electric charging port cover, do not repeatedly open and close the cover continuously.

WARNING

- Do not use this function if the protective packaging or discharge port is disconnected, cracked, open, or shows any damage.
- Do not allow minors to touch or use this device, and keep them away during use.
- Immediately stop using the device if there is any abnormality during discharging.
- Do not touch the plug with wet hands.
- Do not touch the discharge plug pins and the vehicle's discharge socket.
- Do not use this device if the three-phase plug wire becomes soft, or if the discharge gun cable is worn, the insulation layer is cracked, or there are any other damages.
- When using the vehicle's external discharge function, do not place the discharge power strip in a damp environment to avoid rainwater falling on the strip.

Stopping the Discharge Function

1. Unplug the device from the socket, press the switch button, and the socket indicator light goes out;
2. Unlock the vehicle, press and hold the release button, disconnect the discharge cable connector and cover it with the protective cap, then properly store the discharge equipment;
3. Please ensure the dust cover and charging port lid are properly closed.

NOTE

- When stopping discharging, ensure that the time interval between unplugging and replugging the discharge gun is $\geq 3s$.

Discharge Trouble Diagnosis

Possible reasons for the vehicle not discharging:

- The temperature of the power battery is below -20°C or above 45°C . Allow the power battery to heat up or cool down before discharging, and place the vehicle in a suitable temperature environment until the temperature normalizes before discharging;
- Insufficient power battery charge.

Discharge Energy Management

In the "Energy" interface of MP5, you can view the discharge status and set discharge limits.

Tap "Discharge" to enter the discharge settings interface:

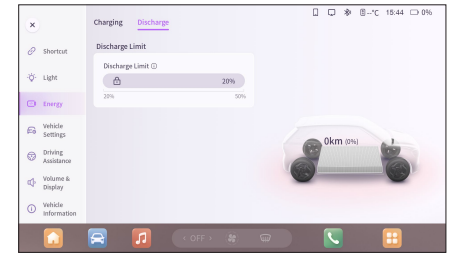

- The MP5 Energy → Discharge interface displays the vehicle status (discharge status, range, battery charge, discharge gun insertion status).
- You can set discharge limits (the lowest discharge limit will not be less than 20%) and end discharging.

Seat Adjustment

Introduction to Seats

Proper seat adjustment ensures maximum effectiveness of seat belts and airbags. Seats can be adjusted in various ways to fit the physique of the driver and passengers:

- Forward and backward position
- Backrest angle

Before driving, make sure to properly adjust the front seats:

- Ensure accurate, effective, and safe operation of all controls on the dashboard.
- Maintain a relaxed, fatigue-resistant sitting posture.
- Maximize the protective function of seat belts and airbags.

CAUTION

- When adjusting the backrest, position it as upright as possible.
- When moving the seat backward, ensure there are no objects under or behind the seat to avoid compressing items or injuring rear passengers.
- Position the seat as far from the dashboard as practical while meeting driving and seating needs.

WARNING

- Never adjust the driver's seat while the vehicle is in motion! Unexpected seat movement can lead to loss of vehicle control and distraction, causing severe accidents.
- Sitting too close to the dashboard can significantly reduce the effectiveness of seat belts and airbags in an accident, leading to serious injuries.
- When adjusting the seat, ensure no one's body parts are in the path of the seat movement.
- The backrest should not be too reclined as it can affect the functionality of seat belts and airbags.
- If the seatback is reclined too far back, the seat belts and airbag system will not provide the expected level of protection. For instance, during braking or in the event of an accident, you may slide under the seat belt, which could result in abdominal or neck injuries. This could increase the risk of causing injury or even fatal harm.

Front Seat

Manual Seat Adjustment



Forward and Backward Adjustment

1. Lift the black unlock lever (1) under the seat and hold;
2. Move the seat forward or backward to the desired position;
3. Release the lever (1) to lock the seat in place;
4. After locking, gently shake the seat back and forth to ensure it's securely locked.

Backrest Angle Adjustment

1. Lift the front end of handle ② and hold;
2. Adjust the backrest to the desired angle;
3. Release handle ② and rock the backrest back and forth to confirm it is fully locked.

CAUTION

After adjusting the seat, shake it back and forth to confirm it's securely locked. An unsecured seat may suddenly move during driving, leading to loss of control.

Power Seat Adjustment*

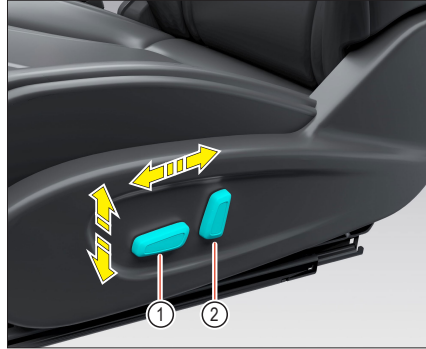

Forward and Backward Position Adjustment

Move forward: Push the switch forward ①;

Move backward: Push the switch backward ①.

Seat Height Adjustment

Raise: Lift the rear end of switch ①;

Lower: Press the rear end of switch ① downwards.

Backrest Angle Adjustment

Tilt Forward: Move the upper end of switch ② forward;

Tilt Backward: Move the upper end of switch ② backward.

NOTE

- The designated position for measuring seat cushion depth is 20mm forward from the rearmost position, with a total forward and backward travel of 260mm.
- The backrest angle is designed to adjust up to 22°.

WARNING

- Never adjust the driver's seat while the vehicle is in motion! Unexpected seat movement can lead to loss of vehicle control and distraction, causing severe accidents.
- Sitting too close to the dashboard can significantly reduce the effectiveness of seat belts and airbags in an accident, leading to serious injuries.
- If the seatback is reclined too far back, the seat belts and airbag system will not provide the expected level of protection. For instance, during braking or in the event of an accident, you may slide under the seat belt, which could result in abdominal or neck injuries. This could increase the risk of causing injury or even fatal harm.

Seat Adjustment

2

Before Driving

Headrest Height Adjustment

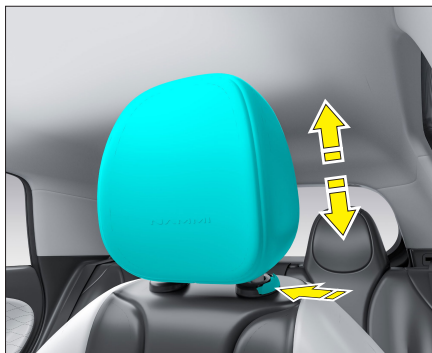

Raising the Headrest

Pull the headrest upwards with both hands to the desired height, then press down to confirm it's locked.

Lowering the Headrest

Hold down the headrest lock button, press down the headrest, and lower it to the appropriate height. Release the headrest lock button, press down on the headrest to confirm it is locked.

Driver's Seat Memory Function*

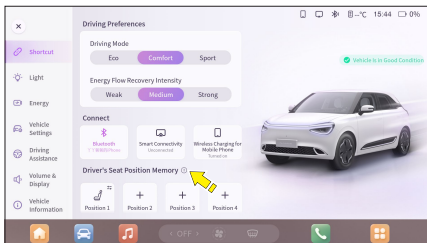

Some models feature a driver's seat memory function for automated seat adjustment during entry/exit and automatic driving position adjustment, which can also be linked with a smart key.

After powering up the vehicle, touch MP5 Shortcut→Driver Seat Position Memory screen to adjust and memorize the new seat position. Up to 4 positions can be memorized and named.

Driver's Seat Welcome Function*

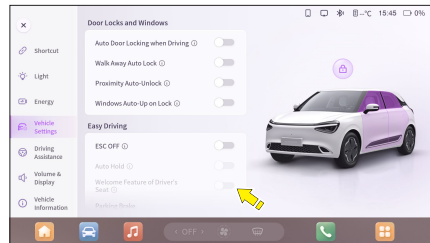

After powering up the vehicle, access MP5 Vehicle Settings→Convenient Driving screen to activate the driver's seat welcome function.

When activated, the driver's seat is in the driving position, and when the driver's door is opened, the driver's seat will move backward.

After the driver's door is closed, the driver's seat will return to its previous position.

⚠ WARNING

Be aware of the space behind the seat during the automatic movement to avoid compression of people or objects.

Driver's Seat Ventilation Function*



After powering up the vehicle, access the MP5 Climate Control screen to activate and adjust the driver's seat ventilation function.

Activating the seat heating function will automatically turn off the seat ventilation function.

Driver's Seat Heating Function*



After powering up the vehicle, access the MP5 Climate Control screen to activate and adjust the driver's seat heating function.

Activating the seat ventilation function will automatically turn off the seat heating function.

Seat Adjustment

Steering Wheel Adjustment

Rear Seat

Folding Down the Rear Seat Backrest

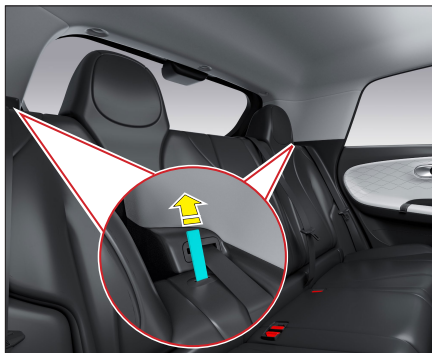

The rear seat can be folded down entirely to expand the trunk's volume.

Pull up the lock cords located at the upper sides of the backrest to their limit and hold them there, while simultaneously flipping the seat backrest forward.

Move the seat belts to the side to avoid interference. Flip the rear seat backrest forward and turn it down to its lowest position.

Restoring the Rear Seat

Move the seat belts to the side to prevent interference, and flip the rear seat backrest backward until you hear two "click" sounds indicating that it is securely in place. Shake the backrest back and forth to ensure it is firmly locked.

CAUTION

When restoring the seat backrest, ensure the seat belts on both sides are placed to the sides to prevent them from getting trapped inside the seat.

Steering Wheel Position Adjustment

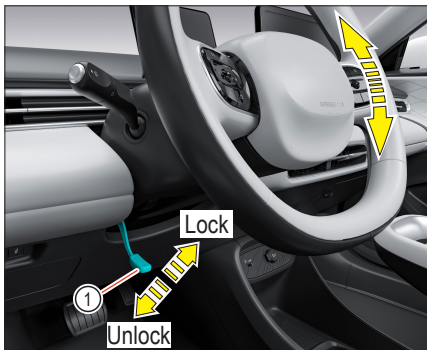

Release the steering wheel adjustment lock handle ① downward to unlock the steering wheel, allowing adjustment of the steering wheel's up and down positions for the comfort and safety of drivers of different statures.

After adjusting, push back the lock handle ① to lock the steering wheel. Shake the steering wheel up and down to confirm it is locked.

CAUTION

Do not forcefully adjust the steering wheel without releasing the lock handle, as this may cause damage to the components.

WARNING

It is strictly forbidden to adjust the position of the steering wheel while driving, as it may lead to severe accidents.

2

Before Driving

External Rearview Mirror

Angle Adjustment of the Rearview Mirror Lens

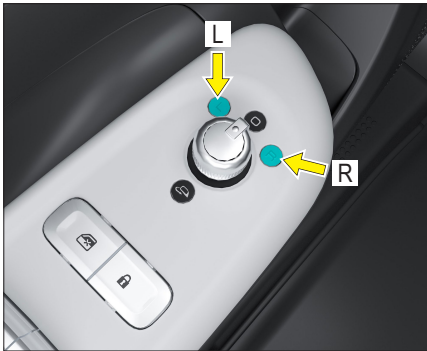

The adjustment device is located on the driver's door armrest.

1. Select the rearview mirror to be adjusted, and turn the adjustment knob to **L** (left external rearview mirror) or **R** (right external rearview mirror) position;
2. Operate the adjustment knob forward or backward to adjust the tilt angle of the external rearview mirror; move the knob left or right to adjust the left or right rotation angle of the mirror;
3. After adjustment, turn the knob to **O** position.

Rearview Mirror Angle Recommendation

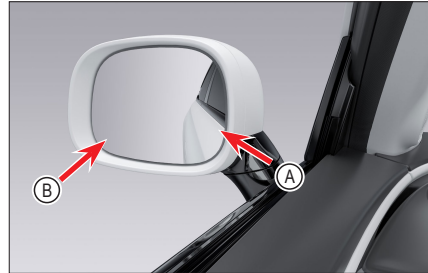

Left and right angle: The car body **(A)** should occupy about 1/4 of the mirror surface.
Up and down angle: The ground **(B)** should occupy about 1/2 of the mirror surface.

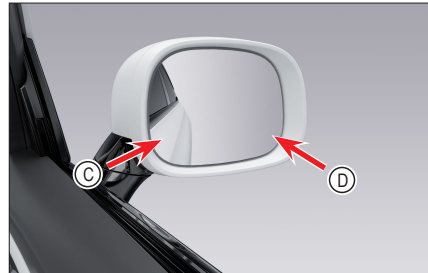

Left and right angle: The car body **(C)** should occupy about 1/4 of the mirror surface.
Up and down angle: The ground **(D)** should occupy about 2/3 of the mirror surface.

⚠ WARNING

- Do not adjust the external rearview mirror while the vehicle is in motion. To concentrate fully on driving, the external rearview mirrors should be adjusted beforehand.
- Avoid touching the mirror lens while adjusting the angle of the external rearview mirror, as this may cause injury to fingers and damage to the mirror.
- Objects reflected in the external rearview mirror appear smaller than they are in reality. The actual distance between the object and the vehicle is closer than it appears. It is essential to correctly estimate the distance of vehicles or objects.

Rearview Mirror Adjustment

2

Before Driving

Manual Folding and Unfolding of Rearview Mirror*



Folding

Gently turn the external rearview mirror inward by holding it with both hands to fold it.

Unfolding

Gently push the external rearview mirror outward with both hands to unfold it.

Before driving, make sure to unfold the external rearview mirror and observe or adjust the angle of the mirror lens for the best view.

Electric Folding and Unfolding of Rearview Mirror*



Twist the electric folding switch for the rearview mirror located on the driver's side door armrest to fold/unfold the external rearview mirror.

Folding

When the adjustment knob is turned to  position, the external rearview mirror will automatically fold.

Unfolding

When the adjustment knob is turned away from  position, the external rearview mirror will automatically unfold.

Manual folding is not recommended unless necessary.

WARNING

- Do not drive with the external rearview mirror folded. This may cause accidents due to the inability to observe the rear of the vehicle.
- If the external rearview mirror frame is displaced due to external force, it must be completely folded using the electric method. Do not manually adjust the mirror frame, as this may affect the mirror adjustment function.

Automatic Folding and Unfolding of Rearview Mirror*

Some models are equipped with an automatic folding feature for the external rearview mirror:

- Automatically folds when locked;
- Automatically unfolds when unlocked.

External Rearview Mirror Heating Function*



After the vehicle is powered on, press the rear window glass defogging/defrosting button  on the MP5 air conditioning interface to activate rear window glass heating for defogging/defrosting, and simultaneously heat the external rearview mirror for defogging/defrosting.

CAUTION

Do not activate the rearview mirror heating function unless necessary, to avoid wasting battery power.

Internal Rearview Mirror

Adjustment of the Internal Rearview Mirror

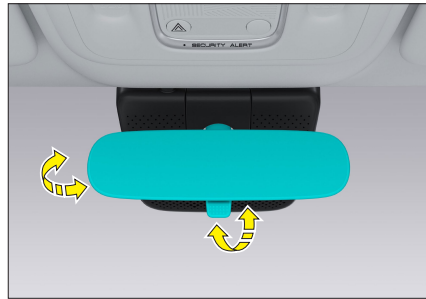

The driver can adjust the internal rearview mirror, aiding drivers of different heights in observing the rear of the vehicle at any time, thus enhancing driving safety.

Hold the internal rearview mirror and adjust the angle of the mirror to the appropriate position in the 4 directions indicated by the arrows in the image.

WARNING

Do not adjust the internal rearview mirror while the vehicle is in motion. To ensure driving safety, minimize the "blind spots" when adjusting the mirror.

Anti-Glare Internal Rearview Mirror

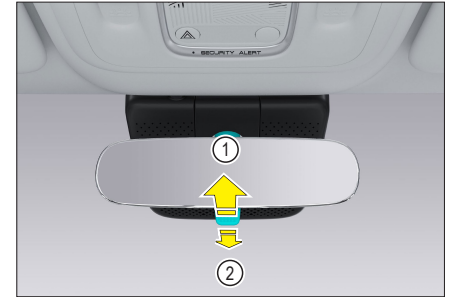

The internal rearview mirror has an anti-glare feature, which reduces the glare caused by the reflection of lights from vehicles behind on the driver's eyes.

At night, if the reflection in the rearview mirror causes glare for the driver, pull the adjustment lever backward in the direction of arrow ① to avoid the glare; during the day, push the adjustment lever forward in the direction of arrow ② to restore the rear view.

Lighting

Light Locations

Light Positions (Front)

2

Before Driving

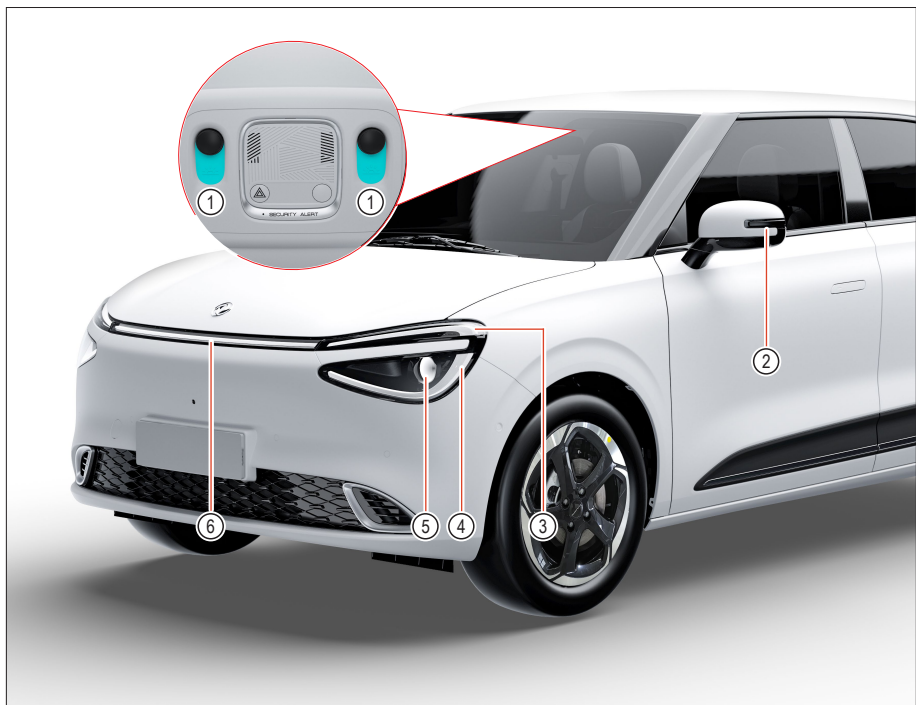

- ① Front Overhead Lights
- ② Side turn signal light
- ③ Front position light/Daytime running light*
- ④ Front position light/Front turn signal light
- ⑤ Low beam light/High beam light
- ⑥ Front through light*

Light Positions (Rear)

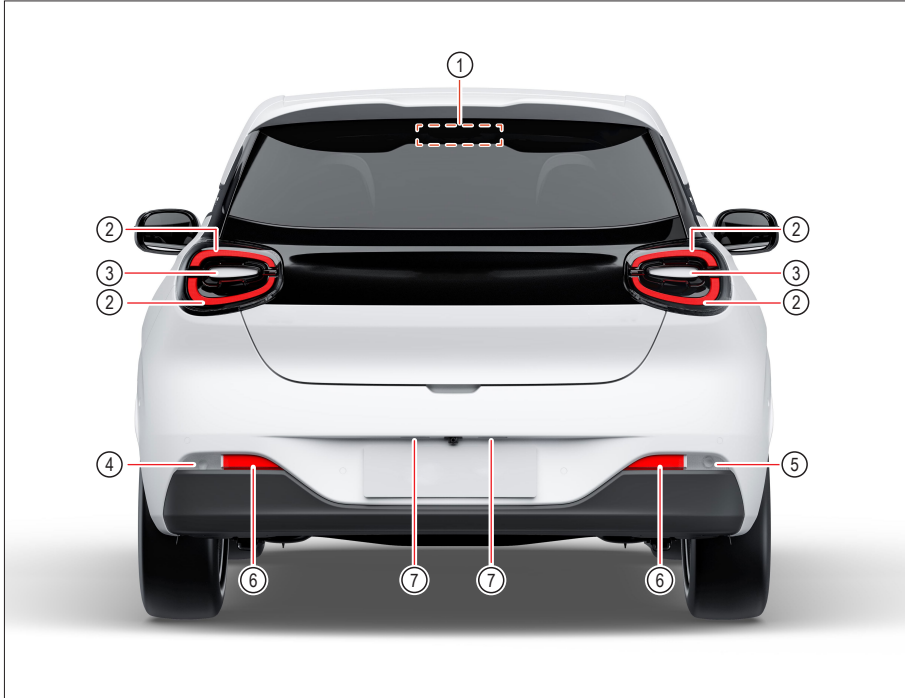

- ① High-Mounted Stop Light
- ② Rear Position Lamp/Brake Light
- ③ Rear Turn Signal Indicator
- ④ Rear Fog Light
- ⑤ Reverse Light
- ⑥ Response Reflector
- ⑦ License Plate Light

Note: Reflectors are used to reflect the light from vehicles behind, reminding the drivers to maintain a safe driving distance. If the reflector is damaged, it should be replaced at a dealership as soon as possible to ensure driving safety.

Lighting

External Lights

Light Switch*

2

Before Driving

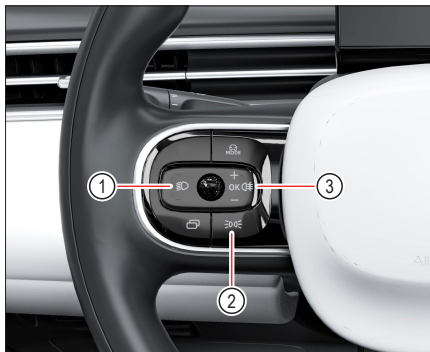

Models without MP5:

- ① Low Beam Light Switch
- ② Position Light Switch
- ③ Rear Fog Light Switch

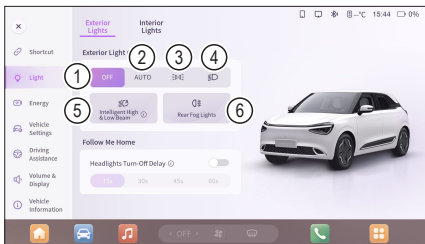

Models with MP5:

- ① Combination Lights Off
- ② Automatic Headlight Switch
- ③ Position Light Switch
- ④ Low Beam Light Switch
- ⑤ Intelligent High-Low Beam Light Switch
- ⑥ Rear Fog Light Switch

Switching Position Lights On

Use the position light switch to turn on the position lights, with the corresponding indicator light  on the instrument cluster illuminating.



 **CAUTION**



The position lights can remain on for a while even after locking the doors.

 **WARNING**

- In conditions of poor visibility, it is strictly forbidden to only turn on the position lights, as this can easily lead to accidents. In such conditions, headlights should be used.
- When temporarily parked, do not use the position lights as parking lights. Instead, turn on the hazard warning lights.

Switching Low Beam Lights On

After powering up the vehicle, turn on the low beam lights, and both the low beam and position lights will come on simultaneously, with the corresponding indicator lights  and  illuminating on the instrument cluster.

Turning off the low beam lights will keep the position lights on, with the indicator light  going off and  illuminating.

Turn on/off the Rear Fog Light

The rear fog light switch can be used to turn on the rear fog lights only after the low beam lights are on, with the corresponding indicator light  illuminating on the instrument cluster.

Use the switch again to turn off the rear fog lights, with the indicator light  going off.

CAUTION

The fog lights should only be used in rainy, foggy, snowy weather, or in conditions of poor visibility.

Switching High Beam Lights On

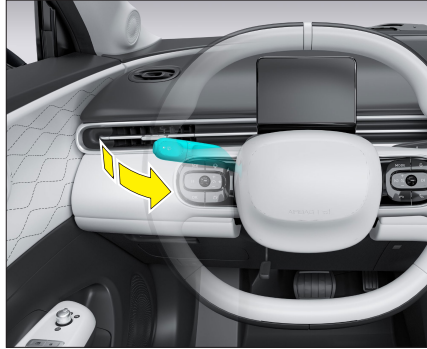

After turning on the low beam lights, push the light control lever toward the instrument panel to turn on the high beam lights, with the corresponding indicator light  illuminating.

Pull the light control lever back toward the steering wheel to turn off the high beam lights, with the indicator light  going off.

High Beam Flashing

Repeatedly pull the light control lever toward the steering wheel and release immediately to make the high beam lights flash.

CAUTION

Using high beam lights in well-lit conditions can dazzle drivers of oncoming vehicles, causing visual errors and potentially leading to traffic accidents. The following points should be noted when using high beam lights:

- At night, alternate between high and low beams when encountering vehicles in the opposite direction. At night on roads without a central barrier or central line, switch to low beams when within 150 meters of an oncoming vehicle.
- When driving at night through sharp curves, slopes, arch bridges, pedestrian crossings, or intersections without traffic signal lights, alternate between high and low beams as a warning.
- Vehicle overtaking at night should alternate between high and low beams; when the vehicle behind flashes high and low beams, yield safely.
- If dazzled by the high beams of an oncoming vehicle, alternate between your high and low beams to remind the other vehicle to switch off their high beams.
- Switch to low beams if an oncoming vehicle frequently switches its lights on you.

Lighting

Turn on/off the Turn Signal

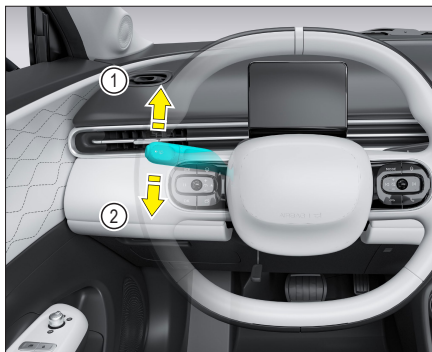

Flip the light combination switch all the way up in direction ① parallel to the plane of the steering wheel to turn on the right turn signal, with the right turn indicator  on the instrument cluster flashing.

Flip the light combination switch all the way down in direction ② parallel to the plane of the steering wheel to turn on the left turn signal, with the left turn indicator  on the instrument cluster flashing.

After completing the turn, the lever will automatically return to its original position, and the turn signal light will also automatically go off.

If the turn signal indicator  on the instrument cluster flashes at a faster rate when the turn signal is on, it indicates a fault in the turn signal light, requiring repair. Please visit a dealership for inspection and repair.

Turn Signal Lane Change Feature

When changing lanes, gently move the light combination switch.

To change lanes to the right, move the light combination switch up in direction ① parallel to the plane of the steering wheel (without exceeding the limit point), and the right turn signal will flash 3 times, with the right turn indicator  on the instrument cluster flashing simultaneously.

To change lanes to the left, move the light combination switch down in direction ② parallel to the plane of the steering wheel (without exceeding the limit point), and the left turn signal will flash 3 times, with the left turn indicator  on the instrument cluster flashing simultaneously.

CAUTION

After completing a turn or lane change, ensure the light combination switch has returned to its original position, or manually return it if necessary.

Headlight Beam Height Adjustment

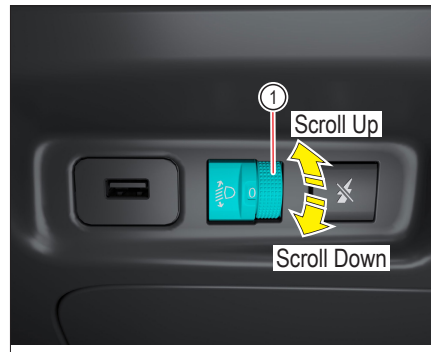



After turning on the low beam lights, the driver can rotate the manual adjustment wheel ① located to the left of the instrument panel to adjust the height of the headlight beam.

Scroll Up: Scroll the adjustment wheel upwards, increasing the number;

Scroll Down: Scroll the adjustment wheel downwards, decreasing the number.

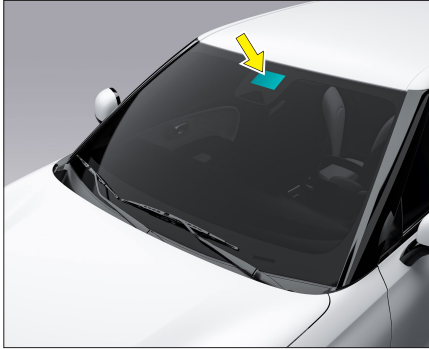
Automatic Headlight Function*



Upon vehicle power-up, the combination light switch defaults to the automatic light position, and the automatic headlight ON indicator  illuminates. When the external light is insufficient, the position lights and low beam lights will automatically turn on, with the position light and low beam light indicators illuminating on the instrument cluster.

When there is sufficient external light, the position lights and low beam lights will automatically turn off. At this time, the corresponding indicators on the instrument cluster will go off.

When the vehicle is stationary, touching the combined light icon will turn off external lighting and the automatic light control mode.

The automatic light sensor is located in the middle of the upper part of the front windshield. Do not cover this area and keep it clean to avoid affecting the automatic light control function.

Intelligent High-Low Beam Function*

After activating the intelligent high-low beam function, the high beam will automatically switch on when no oncoming vehicle headlights, taillights of vehicles traveling in the same direction, or other light sources are continuously detected.

When headlights of oncoming vehicles, taillights of vehicles traveling in the same direction, or other light sources are detected, it will automatically switch to low beam.

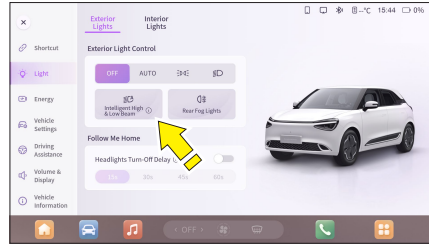

This function can be turned on/off in the MP5 lighting → external lights → external light control interface.

Follow Me Home Feature*

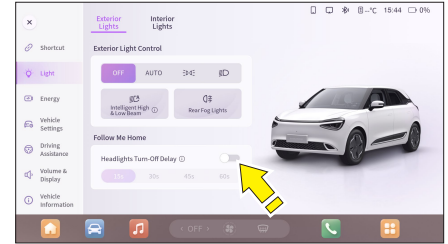

After the vehicle is powered down during night-time parking lock, the Follow Me Home feature can be activated. The headlights automatically turn on and delay turning off, illuminating your way home.

This feature can be enabled or disabled in the MP5 lighting menu under Exterior Lights → External Light Control. You can also set the delay time for the lights to turn off (15s, 30s, 45s, 60s).

Lighting

Response Reflector

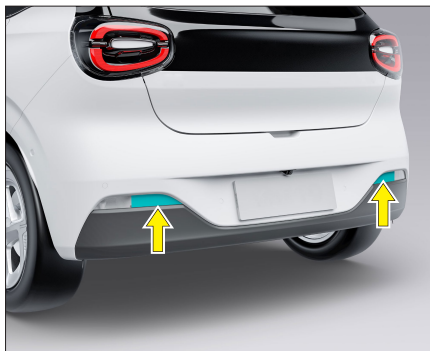

The Response Reflector is designed to reflect the lights of vehicles from behind, reminding the drivers of the trailing vehicles to maintain a safe driving distance.

It's important to keep the surface of the Response Reflector clean. If it is damaged, it should be replaced at an authorized dealership promptly to ensure driving safety.

Interior Lighting

Front Overhead Lights

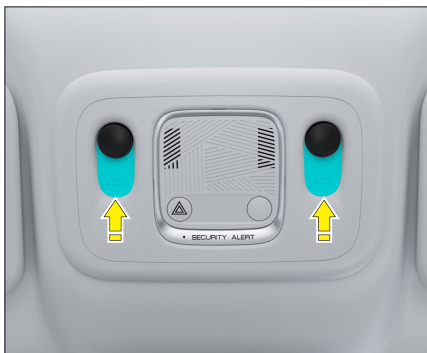

Touch the switch for the front overhead light to turn on or off the corresponding side light.

Delayed Turn-Off of Overhead Lights

If all four doors are closed and the overhead light has been on for more than 15 seconds, it will automatically turn off.

Gradual Dimming of Overhead Lights When Locking

When the vehicle is locked using a smart key or automatic locking upon leaving the vehicle, the overhead lights gradually dim and turn off automatically.

2

Before Driving

Ambient Lighting*



Ambient lighting creates a warm, relaxing atmosphere inside the vehicle, enhancing the comfort of the occupants. It improves interior brightness in low light conditions, creating a soft illumination environment for the cabin.

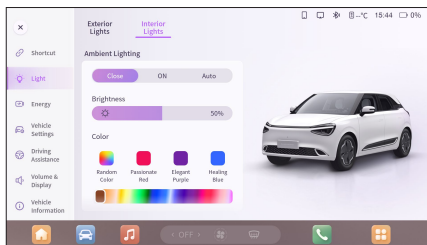

Turning On/Off Ambient Lighting

You can enable or disable ambient lighting in the MP5 lighting menu under Interior Lights → Ambient Lighting.

Automatic Activation/Deactivation with Headlights

In the MP5 lighting menu under Interior Lights → Ambient Lighting, you can set the ambient lighting to automatically turn on with the headlights and position lights, and turn off when they are extinguished.

Brightness Adjustment

The brightness of the ambient light can be adjusted in the MP5 lighting menu under Interior Lights → Ambient Lighting, with 10 levels available.

Color Change

You can set the color of the ambient light in the MP5 lighting menu under Interior Lights → Ambient Lighting, with 32 colors available.

Random Color

You can set the ambient light to randomly change color in the MP5 lighting menu under Interior Lights → Ambient Lighting. The light will switch to a different color each time it is turned off and on again within one power cycle.

LED Vanity Mirror Soft Light*

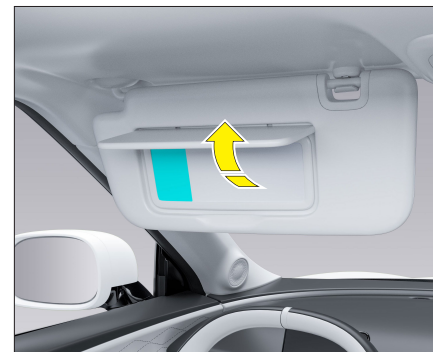

Only the driver's side vanity mirror is equipped with an LED soft light. The light turns on when the sun visor is opened and off when the visor is closed.

Windshield Wipers and Washer

Windshield Wipers and Washer

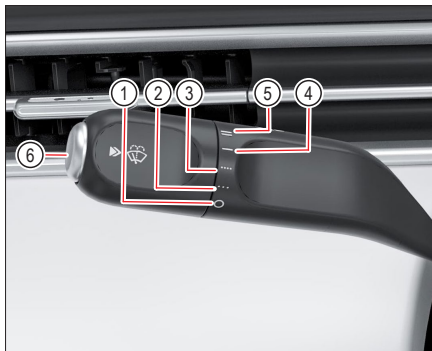

- ① O: Turn off the Wipers
- ② Long Interval Wiper Mode
- ③ Short Interval Wiper Mode
- ④ Low-Speed Continuous Wiper Mode
- ⑤ High-Speed Continuous Wiper Mode
- ⑥ Front Windshield Washer Button - Light press for a single wipe, deep press for spray and wipe

Long Intermittent Wiping

Rotate the wiper combination switch to the short intermittent wiping position; the front wiper operates at a longer intermittent frequency.

Short Intermittent Wiping

Rotate the wiper combination switch to the short intermittent wiping position; the front wiper operates at a shorter intermittent frequency.

Low-Speed Continuous Wiping

Rotate the wiper control switch to the low-speed mode position, and the front wipers will operate in low-speed mode.

High-Speed Continuous Wiping

Rotate the wiper control switch to the high-speed mode position, and the front wipers will operate in high-speed mode.

Turn off the Wipers

Rotate the wiper control switch to the O position to turn off the front wipers.

CAUTION

- Do not operate the windshield wipers if they are obstructed by snow or ice. Instead, activate the windshield defrost function to heat the windshield and remove snow or ice from the wiper arms and surrounding areas before using the wipers.
- If there are stains on the windshield after being wiped by the wipers following an automatic car wash, it could be due to wax or other residues. After washing the vehicle in an automatic car wash, clean the windshield with windshield washer fluid.
- Do not operate the windshield wipers on a dry windshield as dry wiping can damage the wiper blades. Additionally, accumulated dirt on the windshield can scratch the glass. Always spray water before wiping.

Operating the Front Windshield Washer Function



CAUTION

- Use the appropriate type of washer fluid according to your driving environment. Do not dilute with water, as it can damage the windshield washer system.
- Please replace the wiper blades regularly to maintain a good driving view.

Hold down the front windshield wash button, the front nozzles start spraying the washer fluid, then the front wipers begin to wipe.

Release the front windshield wash button, and the front wipers will continue to move 3 times to clean the front windshield glass.

If the button is pressed lightly, the wiper will sweep only once.

Electric Windows

Master Window Control for Driver's Side

2

Before Driving



The master power window switch on the driver's side door armrest can control the raising and lowering of all window glasses and disable the passenger window control switches.

- ① Front Left Window Control
- ② Front Right Window Control
- ③ Rear Left Window Control
- ④ Rear Right Window Control
- ⑤ Passenger Window Control Disable Button

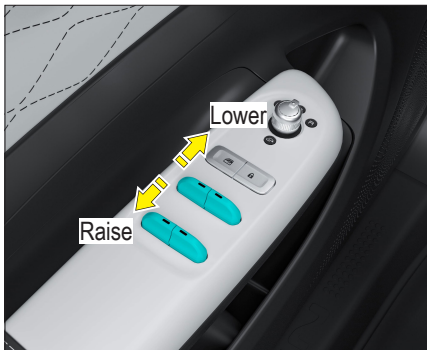

Automatic Mode (One-Touch Operation)

Gently push forward or pull back controls ① ~④ to their limit positions for automatic lowering or raising of the window glass. Releasing the control will stop the movement.

Manual Mode

Gently push forward or pull back controls ① ~④ without reaching the limit points to manually lower or raise the window glass. Release to stop.

Passenger Window Control Disable Button

⚠ WARNING

- Ensure no one is extending any body part out of the vehicle before closing electric windows.
- Never leave children or adults requiring assistance alone in the vehicle. They may inadvertently operate the controls and cause injury, suffocation, or even death.

Feature

Press the switch ⑤, all passenger side window switches will be disabled; press the switch again to enable them.

👁 CAUTION

When children are in the rear seats, it is advisable for the driver to activate the passenger window disable function to prevent children from operating the windows.

Passenger Window Controls

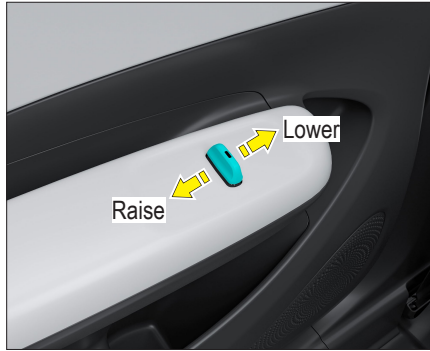

Passenger side window controls allow for the operation of the corresponding side window.

The operation of the passenger window controls is identical to that of the driver's master window control.

When the driver's power window master switch's passenger window switch disable function is enabled, all passenger window switches will be inoperable.

Remote Control for Windows

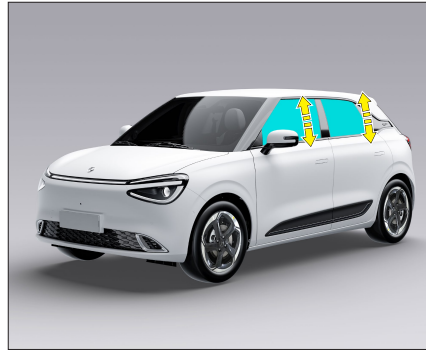

After the vehicle is powered down, holding the lock/unlock button on the smart key can control the automatic raising/lowering of the windows.

Windows Auto-Up on Lock*

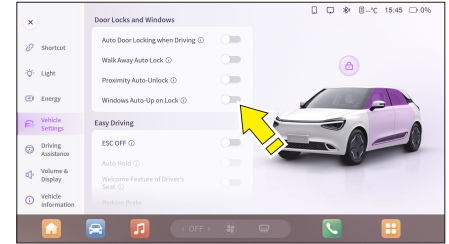

The Windows Auto-Up on Lock function is default off. It can be activated in the MP5 Vehicle Settings → Door and Window menu. Once enabled, all windows will automatically close when the vehicle is locked.

2 Before Driving

Electric Windows

Delayed Power Supply for Windows

Within 30s after powering down, the windows can be normally raised or lowered from any door. After 30 seconds, the windows will not operate.

2

Before Driving

Anti-Pinch Windows

During the closing process, if the window encounters an obstacle, it will immediately lower slightly before stopping.

Window Initialization

Situations requiring initialization include (but are not limited to):

- After disconnecting and reconnecting the battery;
- If the automatic raise/lower function fails;
- If the anti-pinch function fails;
- If the windows don't slightly raise/lower upon closing/opening the doors;
- If the anti-pinch function activates more than 3 times.



Window Initialization Procedure:

1. Close the door needing initialization;
2. Pull the window control switch backward to raise the glass to the top and hold for 5 seconds to complete initialization.

3. When driving

Driving Techniques	92	Electric Power Steering (EPS) System.....	117	Intelligent Speed Limit Control (ISLC)* ..	144
Vehicle Safety Check	92	Brake System	118	Parking Assistance	146
Safety Check Items	94	Brake System Description	118	Reverse Parking Radar	146
Driving Tips for Different Conditions.....	95	Hydraulic Brake System	119	Reverse Camera*	148
Carrying Pets Safely	102	Anti-lock Brake System(ABS)	120	360 Panoramic View*	149
Breaking-in a New Vehicle	102	Electronic Brakeforce Distribution System		Fusion Automatic Parking System*	152
Instrument Cluster	103	(EBD)	120		
Introduction to the Instrument Cluster	103	Brake Assist System(BA)	120		
Indicator and Warning Lights	104	Electronic Stability Control System (ESC) ..	121		
Instrument Panel Card Information		Parking Brake System.....	122		
Switching	107	Driving Assistance	124		
Driving Guide.....	108	Forward Collision Warning (FCW)*	124		
Vehicle Start-Up and Shutdown	109	Autonomous Emergency Braking (AEB)* ..	125		
Electronic Gearshift Operation Instructions.		Lane Keeping Assistance*	127		
.....	112	Adaptive Cruise Control (ACC)*	133		
Driving Modes*	113	Intelligent Cruise Assist (ICA)*	137		
Low-Speed Warning Sound	114	Traffic Sign Recognition (TSR)*	141		
Safe Parking.....	115	Intelligent Speed Assist (ISA)*	143		

Driving Techniques

Vehicle Safety Check

This section introduces important information, operation essentials, suggestions, and safety precautions for safe driving. For the safety of you and your passengers, please read and comply with the relevant regulations carefully.

CAUTION

Always carry this user manual in the vehicle. If you lend or sell the vehicle to someone else, make sure to hand over this manual to the user or the new owner.

Precautions

Keep the Vehicle in a Safe Driving Condition

Vehicle malfunctions can be extremely dangerous for safe driving. To keep the vehicle in a safe driving condition, drivers should visit an authorized dealership for regular maintenance as prescribed in the vehicle's warranty policy, and perform daily maintenance checks before each drive (such as inspecting the drive motor coolant, brake fluid, and windshield washer fluid).

Pre-Driving Checks

1. Ensure there are no obstacles around the vehicle and check for oil leaks under the car.
2. Visually inspect the tires for cuts, damage, excessive wear, or bulges, and check that the tire pressure is normal.
3. Check that all windows and lights are clear and bright.
4. Adjust the seat position and height to a comfortable setting.
5. Adjust both interior and exterior rearview mirrors to the appropriate positions.
6. Fasten your seatbelt and ensure all passengers do the same. Check that all doors are securely closed.
7. Upon powering up the vehicle, check the functioning of the warning lights.
8. Release the parking brake and ensure the brake system warning light is off.

Correct Seat Adjustment

Before driving, all occupants should adjust their seats to an upright position, properly position the seats, and correctly wear seat belts.

Always Wear Seat Belts

Airbags provide supplementary protection but cannot replace the protective function of seat belts in accidents. Therefore, all occupants must wear seat belts correctly while the vehicle is in motion.

Properly Secure All Child Passengers

Children should be properly placed in the rear side seats. If a child is too small to wear a seat belt, they must be securely placed in a child safety seat.

Be Aware of the Dangers of Airbags

While airbags offer protection, they can also cause injury to passengers sitting too close or not properly secured, especially infants. Please follow the guidelines in this manual regarding airbag safety.

Never Drive Under the Influence

Do not drive under the influence of alcohol. Alcohol impairs your ability to react to changes in the environment, so never drive after consuming alcohol, even a small amount.

Do Not Speed

Speeding is one of the main causes of fatal vehicle collisions. The faster you drive, the greater the risk. Never exceed the road's speed limit and the safe driving speed for the current road conditions.

Drive Carefully

- Drive Carefully
- Avoid sudden acceleration or braking.
- Avoid sharp turns or sudden lane changes.
- Avoid sudden turns.
- Keep a safe distance from the vehicle in front.

Adapting to specific road and weather conditions (such as high winds, dust, heavy rain, water crossing, mountainous areas, and heavy snow) is necessary for safe and comfortable driving. As a driver, you should be well aware of how to drive the vehicle in specific environments.

Driving on Wet Roads

- Avoid sudden acceleration or braking.
- Avoid sharp turns or sudden lane changes.
- Keep a safe distance from the vehicle in front.

When there are puddles, water accumulation, or small streams on the road, slow down to prevent skidding and loss of control. Excessively worn tires increase this risk.

Loading

 CAUTION
<p>The distribution of cargo on the vehicle can significantly alter its driving characteristics. Therefore, adjust your driving style accordingly, especially when heavily loaded, and reduce speed as necessary.</p>

 WARNING
<ul style="list-style-type: none"> ● Do not get distracted while driving, for example, by smoking, eating, talking to passengers, or using the phone. ● Avoid driving when your reaction capability is impaired, such as after taking medication that causes drowsiness, alcohol, or drugs, which can weaken reaction times and lead to serious accidents. The World Health Organization has listed 7 categories of medications that may impair safe driving after consumption and recommends prohibiting driving after taking these medications. These 7 categories include: hypnotics that affect the nervous system, medications that cause nausea, vomiting, or allergic reactions, analgesics, stimulants, antiepileptic drugs, as well as antihypertensive and antidiabetic medications. ● Strictly adhere to traffic regulations and speed limits. ● Always control your speed to suit the current road conditions, traffic flow, and weather conditions.

Driving Techniques

Safety Check Items

Performing a safety check before setting off is advisable. A few minutes of inspection can contribute to safer driving and familiarization with the vehicle. These checks can be executed with careful observation.

Before Starting the Vehicle

Exterior of the Vehicle:

Tires:

Check the tire pressure and inspect the tires for cuts, damage, excessive wear, or bulges.

Wheel Bolts:

Ensure no bolts are missing or loose.

Lights:

Ensure that headlights, brake lights, reverse lights, turn signals, and other lights are functioning properly. Check the direction of the headlight beams.

Under the Hood:

Fluid Levels:

Ensure all vehicle fluid levels are normal, such as coolant and brake fluid.

12V Battery and Cable Condition:

Check for cracks in the 12V battery casing, corrosion or looseness at the terminals, and ensure cable connections are in good condition.

Inside the Vehicle:

Seat Belts:

Check and confirm that the buckle and latch can be fastened securely. Ensure the seat belts are not worn or damaged.

Instruments and Controls:

Ensure the instrument panel lights and defrost/defog functions are working properly.

Brake Pedal:

Check and ensure the pedal has sufficient travel.

After Starting the Vehicle

Before Moving:

Fluid Leaks:

After the vehicle has been stationary for a while, check underneath for leaks of oil, water, or other fluids. Dripping water after using the air conditioner is normal.

While Driving:

Instruments:

Ensure no red or yellow warning lights are illuminated on the instrument panel.

Brakes:

When safe to do so, drive at low speed and apply the brakes to check for reliable braking, no vehicle deviation, and no unusual noises from the brakes.

Noise:

Be attentive to any unusual noises from the vehicle.

Driving Tips for Different Conditions

Driving in the Rain

When it rains, visibility is reduced, windows may fog up, and roads become slippery, so please drive carefully.

Heavy rain can impair visibility. When driving, turn on the headlights, fog lights, and hazard warning lights.

Water on the brakes can affect braking efficiency. Therefore, increase the following distance and reduce speed in rainy weather.

Do not drive at high speeds in the rain, as the faster you go, the more likely it is for hydroplaning to occur between the tires and the road surface.

⚠ WARNING

When driving on wet and slippery roads, emergency braking, sudden acceleration, and sharp turns can all lead to tire skidding, reducing vehicle control and potentially causing accidents.

👁 CAUTION

If there is standing water on the road, there is a risk of hydroplaning. Therefore, on wet and slippery roads, it is necessary to: reduce speed, avoid sudden turns, and brake cautiously.

Driving Through Water



When driving through areas with standing water, please note the following:

1. Before driving through water, correctly estimate or ascertain the depth of the water and the characteristics of the area. The water depth should not exceed the lower edge of the car body. Do not force your way through standing water in unknown areas.
2. If you need to drive through water, turn off the air conditioning before starting, choose a flat area, and cross the waterlogged section at a steady and slow speed.
3. After driving through water, lightly press the brake pedal several times to dry the brakes and restore braking power.
4. After driving through water, promptly remove any mud from the tire tread.

Driving Techniques

Winter Driving

Drive Carefully Avoid sudden acceleration or braking. Avoid sharp turns or sudden lane changes. Maintain a reasonable distance from the vehicle in front.

Winter Preparation

1. Use fluids suitable for low-temperature environments:
 - Drive Motor Coolant
 - Windshield Washer Fluid
2. Check the tires, ensuring sufficient tread depth, or switch to snow tires.
3. Check the 12V battery to ensure it is in good condition.
4. It is recommended to carry necessary emergency tools: ice scraper, flashing signal device, snow shovel, jumper cables, air pump, etc.
5. When winter approaches, visit a dealership for vehicle winter protection maintenance.

CAUTION

Be extra cautious when driving on slippery roads, avoiding sudden acceleration, braking, and sharp turns.

Before Driving the Vehicle

Do not forcibly open frozen doors, windows, or move frozen windshield wipers. Use warm water to melt the frozen parts, and immediately wipe off the water to prevent refreezing.

To ensure the normal operation of the heating system, clear snow from the air intake vents below the windshield.

Check and remove ice and snow that may have accumulated on the front and rear windshields, exterior lights, roof, chassis, around the tires, or on the brakes.

Before entering the vehicle, clean off any snow or mud from the soles of your shoes.

CAUTION

- When removing snow and ice from front and rear windows, be careful not to damage the plastic components on the windows.
- If doors or retractable door handles are frozen, do not forcibly open them, as this may damage the seals around the doors. Use warm water to melt the ice around the door edges before opening.

Winter Parking

Under normal conditions, the parking brake must be engaged.

In icy and snowy environments, when parking on flat ground, place the electronic shift lever in "P" position. Do not engage the parking brake if it's safe to do so, as the parking brake may freeze, making it difficult to release. If necessary, use appropriate methods to block the wheels.

CAUTION

Avoid parking on steep slopes if possible. If parking on a steep slope is necessary, even in icy and snowy conditions, the parking brake must be engaged, and other methods should be used to secure the wheels.

Driving the Vehicle

Start smoothly, accelerate slowly, maintain a sufficient safe distance from the vehicle in front, and adjust speed according to road conditions.

In cold temperatures, after starting the vehicle, drive slowly for a few minutes, allowing the drive motor to warm up before proceeding to normal driving.

Snow Tires

On icy and snowy roads, where slipping is very likely, using snow tires can significantly improve vehicle safety performance. If the winter driving environment frequently involves icy and snowy road conditions, consider switching to snow tires, keeping in mind the following:

Use radial snow tires of the same size as the original tires.

For optimal driving performance, all four wheels should be fitted with snow tires.

If the tread depth of the snow tires is worn down to 4mm or they are aged, they essentially lose their unique performance advantages.

The inflation pressure for snow tires must be 20kPa higher than regular tires, but not exceed 350kPa.

Follow local regulations when using snow tires.

Do not keep snow tires on the vehicle for extended periods, as regular tires perform better on roads without ice and snow.

Anti-Skid Chains

Do not install unapproved anti-skid chains. Inappropriate snow chains can damage the vehicle's tires, wheels, brakes, and body. When using them, please pay attention to the following requirements:

- Suitable anti-skid chain size for vehicle wheel size should be selected;
- 9mm specification anti-skid chains are recommended;
- Anti-skid chains can only be installed on the drive wheels (front wheels);
- Please follow the anti-skid chain installation instructions and speed limits for different road conditions.
- To prevent tire damage and excessive wear of the chains, be sure to remove the anti-skid chains when driving on non-snowy roads.

⚠ WARNING
<ul style="list-style-type: none"> • Comply with relevant regulations when driving with anti-skid chains, and do not exceed a speed of 40km/h. • Remove the anti-skid chains on roads without ice and snow.

👁 CAUTION
<p>This manual provides technical reference information for the use of snow tires and anti-skid chains. Snow tires and anti-skid chains are not included in the vehicle's equipment range.</p>

Winter Specific Equipment

When driving in winter, it is recommended to carry the following equipment:

- Plastic or silicone scrapers and brushes for removing ice and snow from windows.
- A metal shovel for digging the vehicle out of snow.

12V Battery

In particularly cold climates, if the 12V battery is undercharged, the battery fluid can freeze and damage the 12V battery.

Coolant

Before using the vehicle in cold regions, visit a dealership to replace the coolant with a proper grade of genuine coolant.

Driving Techniques

Anti-Corrosion

Chemical agents used for de-icing roads are highly corrosive and can accelerate the corrosion and damage of vehicle underbody components such as brake lines, brake cables, chassis, and mudguards.

In winter, regularly clean the vehicle's underbody.

In extremely cold regions, more rust-proofing and anti-corrosion measures may be necessary. Consult your local dealership.

Windshield Washer

In cold winters, ice and snow can freeze on the windshield, impairing visibility. Washer fluid can freeze, blocking the pipes and nozzles, making it unusable. Frozen washer fluid can crack the washer fluid reservoir and pipes, so antifreeze washer fluid should be used.

When the windshield is covered with snow or ice, use the windshield defroster to melt the snow or ice before using the wipers.

WARNING

- Drive carefully under all conditions, accelerating and decelerating very carefully. If you accelerate or brake suddenly, the drive wheels may lose more traction.
- On wet and slippery roads, maintain a longer braking distance. Begin braking earlier than on dry roads.
- Wet ice (0°C and freezing rain) and extremely low-temperature snow or ice are very slippery, making driving challenging. Traction or grip on these surfaces is significantly reduced. Avoid driving on wet ice, and even if the road is sanded, still drive carefully.
- Watch out for smooth areas (glaring ice), usually found in shaded parts of the road. If you see ice patches ahead, start braking early. When driving on ice, try to avoid sudden braking and sudden steering maneuvers.

Braking Techniques

Braking Precautions

After braking, remove your foot from the brake pedal. Resting your foot on the brake pedal for extended periods during driving can inadvertently apply the brakes, causing overheating of the brake system. This increases braking distance and may lead to brake system failure, posing a risk of accidents. It also causes excessive, premature wear of brake pads and increased energy consumption.

Do not simultaneously press the brake and accelerator pedals while driving.

WARNING

During driving, it is strictly forbidden to switch off the vehicle's power, as this will render the brake assist ineffective. Considerable force is required to press the brake pedal to activate the brakes, which is extremely dangerous.

CAUTION

- When the ABS system is functioning normally, you may feel a slight vibration in the brake pedal.
- Do not release the pedal at this time; continue to press it firmly to the floor. In an emergency braking situation, press the brake pedal as quickly as possible and fully to the floor.

After strong braking, do not immediately park the vehicle. Instead, continue driving a short distance to allow airflow to cool the brakes more quickly.

Downhill Braking



When driving downhill, releasing the accelerator pedal or lightly pressing the brake pedal will cause the vehicle to brake.

Avoid continuously light pressing of the brake pedal (pumping), as this may reduce the brake vacuum assist and affect braking efficiency.

Wet Surface Braking

If you drive in heavy rain for a long time without applying the brakes, the first braking action might be delayed due to wet brakes.

Braking may also be delayed after washing the vehicle or driving through deep water.

On wet surfaces, braking distances are longer, so it's important to maintain a greater following distance from the vehicle ahead.

After washing the vehicle or driving on wet surfaces, lightly press the brake pedal several times, when traffic conditions allow, to increase the temperature of the brake discs and dry the brakes, thereby restoring braking power.

Driving Techniques

Braking on Roads Treated with De-Icing Salt

When driving on roads treated with de-icing salt, a layer of salt may form on the brake discs and pads, which can significantly increase braking distance. Follow these instructions:

1. Apply brakes intermittently to prevent salt accumulation, ensuring the safety of other road users.
2. Carefully press the brake pedal at the end of your journey or before starting the next journey.
3. Maintain a greater distance from the vehicle in front.

New Brake Pads

Newly replaced brake pads and discs only achieve optimal braking efficiency after a break-in period. Therefore, in the initial stages of use, more force must be applied to the brake pedal to achieve braking effects.

It is recommended to install only approved or equivalent quality standard brake pads on the vehicle. Brake pads not meeting equivalent quality standards may affect the vehicle's braking efficiency.

Efficient Use of the Vehicle

1. Maintain correct tire pressure. Insufficient pressure leads to abnormal tire wear and increased energy consumption.
2. Do not store unnecessary items in the vehicle. Excessive load increases the burden on the drive motor and leads to higher energy consumption.
3. Accelerate slowly and smoothly, avoiding rapid starts.
4. Avoid traffic congestion, as continuous acceleration and braking deplete energy.
5. Avoid unnecessary stopping and braking, maintain a steady speed. Drive in sync with traffic lights to minimize stops or choose roads without traffic lights. Maintain a safe distance from other vehicles to avoid emergency braking, reducing brake wear.
6. Do not rest your foot on the brake pedal. This causes premature wear and overheating of the brake pads, and increased energy consumption.
7. Drive at low speeds in crosswinds for easier vehicle control.
8. Ensure correct driving trajectories to avoid scraping tires against sharp objects or curbs, which may cause serious accidents like tire bursts.
9. Avoid colliding with curbs while the vehicle is in motion. Reduce speed when driving on uneven road surfaces.
10. Keep the vehicle's undercarriage free from mud to reduce weight and prevent corrosion.
11. Regularly maintain the vehicle to keep it in good working condition. To extend the service life of all components and reduce operating costs, regular maintenance is essential. If you frequently drive under harsh conditions, you should reduce the maintenance interval mileage and period.
12. Ensure accurate wheel alignment to prevent rapid tire wear and increased load on the drive motor, which accelerates energy consumption.
13. After washing the vehicle or driving through deep water, the brakes may become wet. Drive slowly and press the brake pedal lightly several times to dry the brakes quickly, ensuring driving safety. Drive carefully, and if the brakes still do not function safely, stop and contact the dealership.

 CAUTION

- Ensure the parking brake is released before driving.
- Do not rest your foot on the brake pedal while driving, as this can lead to overheating, unnecessary wear of brake pads, and wastage of energy.
- When descending long, steep slopes, reduce speed. Overuse of brakes can lead to overheating and malfunction.
- Be cautious when accelerating or braking on smooth surfaces. Sudden acceleration or using drive motor braking can cause the vehicle to skid.
- Avoid waterlogged roads to prevent soaking the brakes.

Driving Through Tunnels

The human eye needs time to adapt to sudden changes in light, such as when entering or exiting tunnels. Keep these points in mind:

1. Slow down and maintain a safe distance from the vehicle ahead.
2. Pay close attention to traffic signs or information boards.
3. Turn on headlights in advance and avoid using the horn.

Energy-Efficient Driving

Here are some measures for energy-efficient driving:

1. Remove unnecessary cargo before driving.
2. Keep tires at the proper pressure.
3. Start and accelerate smoothly, avoiding sudden accelerations and decelerations.
4. Plan your route and choose well-maintained roads.
5. Drive at an economical speed.
6. Keep windows closed when driving at high speeds.
7. Use air conditioning judiciously and minimize the use of high-power audio and other high-power electrical devices.
8. Regularly maintain your vehicle according to the maintenance schedule to keep it in good condition.

Driving Techniques

Carrying Pets Safely

If carrying pets in the vehicle, please ensure the following:

1. Do not play with pets while driving, as this can lead to serious accidents.
2. Ensure animals are properly secured during the journey, such as in a pet carrier. Unsecured pets may interfere with the driver's control of the vehicle, causing serious accidents.
3. In the event of an accident, sudden turn, or emergency braking, unsecured pets can be thrown around inside the vehicle, causing injuries.
4. Never leave pets unattended in the vehicle, as they may accidentally activate vehicle equipment, leading to serious accidents. Pets can also suffocate in a closed vehicle.

Breaking-in a New Vehicle

Break-in Precautions

To enhance the lifespan of the vehicle, a new vehicle should undergo a break-in period.

1. The break-in mileage is 1500km.
2. Drive on better roads with light loads.
3. Start and drive gently with moderate speeds, not exceeding 80% of the maximum speed.
4. Avoid flooring the accelerator pedal for rapid acceleration.
5. Avoid emergency braking within the first 300km.
6. Strictly follow operating procedures, take good care of daily maintenance, and pay attention to the sound and temperature changes of various assemblies.

Breaking-in Tires and Brake Pads

Drive at moderate speeds for the first 500km to properly break in new tires.

New brake pads and discs will not achieve the best friction state within the first 300km. Avoid emergency braking, maintain a sufficient safe braking distance, and gently press the brake pedal to achieve the optimal break-in state.

WARNING

- New tires and brake pads that have not been broken in do not have optimal adhesion and friction, so extra caution is needed during the first 500km to prevent accidents.
- After replacing new tires and brake pads, they also need to be broken in.
- Maintain a safe distance from other vehicles while driving, avoid emergency braking, as new tires and brake pads have not yet been fully broken in, and their insufficient adhesion and friction can easily lead to traffic accidents.

Introduction to the Instrument Cluster

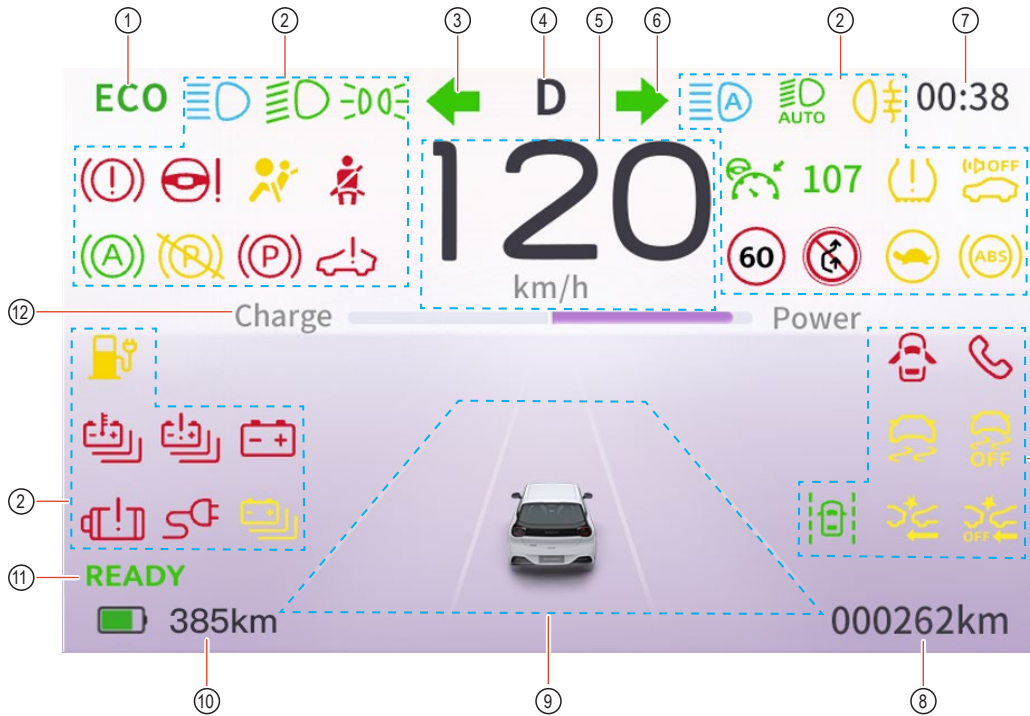

- ① Driving mode display
- ② Vehicle Operation Indicator and Warning Lights
- ③ Left Turn Signal Indicator
- ④ Gear Display
- ⑤ Instantaneous speedometer
- ⑥ Right Turn Signal Indicator
- ⑦ Time display
- ⑧ Total mileage display
- ⑨ Vehicle status & ADAS road information & Card information & Popup display
- ⑩ Battery Charge & Remaining Mileage Display
- ⑪ READY indicator
- ⑫ Motor Drive Power and Energy Recovery Display

Instrument Cluster

Indicator and Warning Lights

High Beam Indicator Light

This light illuminates when the high beams are activated.

Low Beam Indicator Light

This light illuminates when the low beams are activated.

Position Light Indicator

This light illuminates when the low beams are activated.

Left Turn Signal Indicator

This light flashes when the combination switch for lights is moved downward.

Rapid flashing indicates a malfunction in the turn signal or circuit, necessitating an immediate check at the dealership.

Right Turn Signal Indicator

This light flashes when the combination switch for lights is moved upward.

Rapid flashing indicates a malfunction in the turn signal or circuit, necessitating an immediate check at the dealership.

Intelligent High-Low Beam Indicator*

The Intelligent High-Low Beam System (IHBC) indicator lights up on the instrument panel under different operating conditions:

 Gray illuminated- System in standby mode;

 Blue illuminated- System in operation;

 Orange illuminated- System in fault condition.

Automatic Headlight Indicator

This light illuminates when the automatic headlight function is activated.

Rear Fog Light Indicator

This light illuminates when the rear fog lights are activated.

Brake System Warning Light

During vehicle operation, if this light illuminates, stop the vehicle safely and promptly to check the brake fluid level.

If the fluid level is adequate and the light remains on, contact the dealership immediately for a vehicle inspection.

EPS Malfunction Warning Light

If this light illuminates while the vehicle is in motion, it indicates a potential malfunction in the Electric Power Steering system, requiring immediate dealership inspection.

In the event of an EPS malfunction, steering assistance is lost, but vehicle control is still possible. Greater effort will be needed, especially during sharp turns and low-speed maneuvers.

Airbag System Malfunction Warning Light

If the airbag system warning light illuminates while the vehicle is in motion, it indicates that the Supplemental Restraint System (SRS) needs to be serviced. Contact an authorized dealer immediately for repairs.

The airbags may not function properly until serviced.

Seat Belt Unfastened Warning Light

This light illuminates when the vehicle is powered on and remains on until the driver's seat belt is fastened. If the vehicle reaches 10 km/h with the seat belt unfastened, the light flashes accompanied by a beeping sound and a popup on the instrument panel, indicating the urgency to fasten the seat belt.

 Door Ajar Warning Light

This light illuminates when a door is not properly closed.

 ICA Status Indicator*

The ICA (Intelligent Cruise Assist) function's status is indicated on the instrument panel:

 Green illuminated- System in operation;

 Orange illuminated- System in reduced functionality;

 Red illuminated- System in fault condition.

 ACC Status Indicator*

The ACC (Intelligent Cruise Assist) function's status is indicated on the instrument panel:

 Green illuminated- System in operation;

 Red illuminated- System in fault condition.

 Cruise Control Status Indicator*

This light illuminates when the cruise control system is actively controlling the vehicle.

 Tire Pressure Warning Light

This warning light illuminates during vehicle operation if tire pressure is low or a tire is damaged. Stop the vehicle safely and immediately to inspect the tires for normalcy or punctures.

The tire pressure warning light will also illuminate after changing wheels or rotating tires. Visit the dealership for a vehicle check.

 AUTO HOLD Indicator*

This light illuminates when the automatic parking feature is activated.

 EPB Malfunction Warning Light

This light illuminates if there is a malfunction in the Electronic Parking Brake system. Visit the dealership for a vehicle check.

 EPB Engaged Indicator

This light illuminates when the Electronic Parking Brake is engaged.

 System Malfunction Warning Light

If this light remains illuminated after vehicle power-up or lights up while driving, it indicates a power system malfunction. Immediate dealership inspection is advised to avoid potential vehicle damage.

 Performance Limit Indicator

If this light illuminates during vehicle operation, the power supplied to the drive motor is reduced, resulting in insufficient power during acceleration. Visit the dealership immediately for a check.

 ABS Malfunction Warning Light

If this light illuminates while driving, it may indicate a malfunction in the ABS (Anti-lock Braking System). Immediate dealership inspection is necessary.

In case of ABS malfunction, the anti-lock feature will cease to function, but normal braking will remain operational.

Instrument Cluster

High-Temperature Battery Warning Light

This light illuminates when the power battery temperature is too high.

If it illuminates during vehicle operation, stop the vehicle safely and immediately, and contact the dealership for a check.

Power Battery Malfunction Warning Light

This light illuminates in case of a power battery malfunction.

If it illuminates during vehicle operation, contact the dealership promptly for a vehicle check.

12V Battery Charging Malfunction Warning Light

Under normal circumstances, the 12V battery charging fault warning light illuminates when the vehicle is powered on. After a few seconds, the light goes out.

If the 12V battery system fault warning light illuminates while the vehicle is in motion, it indicates a problem with the 12V battery system, and the vehicle should be taken to an authorized dealership for inspection immediately.

T-BOX Malfunction Indicator*

If this light stays on after the vehicle is powered up, it indicates a malfunction in the T-BOX function.

When the T-BOX malfunction indicator remains lit, promptly visit a dealership for vehicle inspection.

ESC Malfunction Light*

When the ESC (Electronic Stability Control) is operational, the ESC malfunction warning light flashes about three times per second.

When the ESC is neither malfunctioning nor in operation, the warning light is off.

If the ESC malfunction warning light stays on, it indicates a malfunction in the ESC system, necessitating immediate inspection or repair at a dealership.

Forward Collision Warning (FCW) / Autonomous Emergency Braking (AEB) Malfunction Warning Light*

If this yellow warning light illuminates while the vehicle is in motion, it indicates a malfunction in the FCW/AEB system. Immediate inspection or repair at a dealership is recommended.

Drive Motor Malfunction Warning Light

This light illuminates in the event of a drive motor system malfunction.

If the drive motor malfunction warning light illuminates while driving, it indicates an issue with the drive motor system, and immediate contact with a dealership for vehicle inspection is advised.

Charging Cable Connection Indicator

When charging, connect the charging plug, and the light stays on. If the light is flashing, it indicates a failure to charge normally. Check if the charging source is connected, whether there's an indicator light for control box malfunction on the charger, and if the charging terminal's display shows any faults. If it continues to flash, promptly visit a dealership for a check of the vehicle's charging system.

Charging Reminder Indicator

The indicator light illuminates when the power battery is low.

 Charging Reminder Indicator

During vehicle charging:

1. While charging, the indicator light flashes;
2. In case of a charging fault, the indicator light flashes rapidly;
3. When charging is complete, the indicator light turns off.

 LKA function status indicator*

The LKA (Intelligent Cruise Assist) function's status is indicated on the instrument panel:

 Green illuminated- System in operation;

 Red illuminated- System in fault condition.

 LDW function status indicator*

The LDW (Intelligent Cruise Assist) function's status is indicated on the instrument panel:

 Green illuminated- System in operation;

 Red illuminated- System in fault condition.

 ESC OFF indicator*

If the ESC OFF indicator stays on while the vehicle is in motion, it indicates that the vehicle's ESC control function is disabled, requiring cautious driving.

The driver can enable or disable the ESC function by pressing the ESC OFF switch.

 FCW/AEB Off Indicator*

When the Forward Collision Warning (FCW) / Automatic Emergency Braking (AEB) systems are turned off, the indicator light illuminates in yellow.

READY Vehicle Ready Indicator

When the gear is in the "P" (Park) or "N" (Neutral) position, the driver's side door is closed, the driver's seat belt is fastened, and the brake pedal is depressed, the vehicle is ready to start and the READY indicator lights up, indicating the vehicle is prepared for driving.

Instrument Panel Card Information Switching

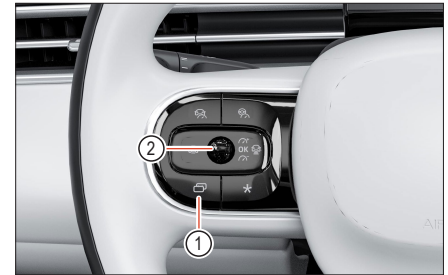
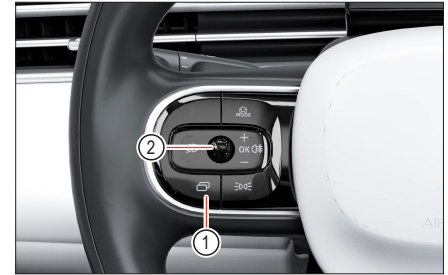

Press the instrument function switch button ① on the left side of the multifunction steering wheel to switch the display of card information on the instrument panel. Some functions can be adjusted via Settings ②.

Driving Guide

3

When Driving

Trip Odometer Display



Pressing the switch button ① toggles between Trip A and Trip B subtotal information, displaying subtotal mileage, average electricity consumption, and average speed.

Instantaneous Electricity Consumption Display

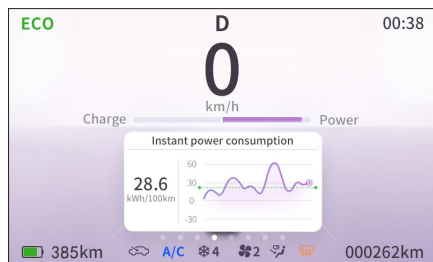

It can also switch to display instantaneous electricity consumption.

Vehicle Maintenance Display

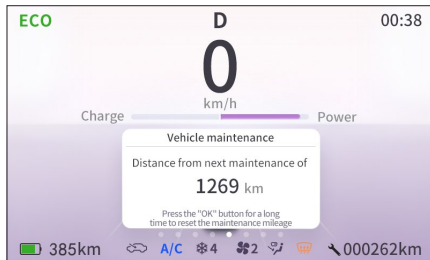

Vehicle maintenance reminder information is also displayed. When the distance to maintenance is less than 500km, a popup will display "Distance from next maintenance of XXX km" every time the vehicle is powered on.

Tire Pressure Information Display

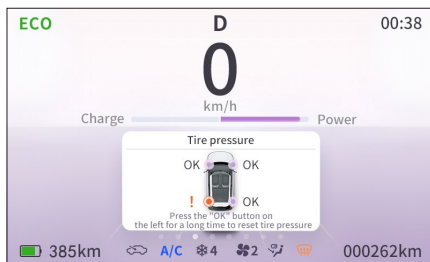

It can also display tire pressure monitoring information.

Instrument Panel Brightness Adjustment

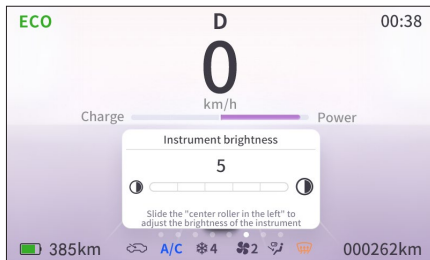

For models without MP5: Press the switch button ① to the brightness adjustment interface, and adjust the brightness using the scroll wheel ②.

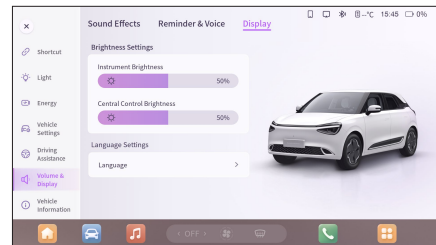

For models with MP5: Adjust the instrument panel brightness in the MP5 Volume & Display → Display interface.

Vehicle Start-Up and Shutdown

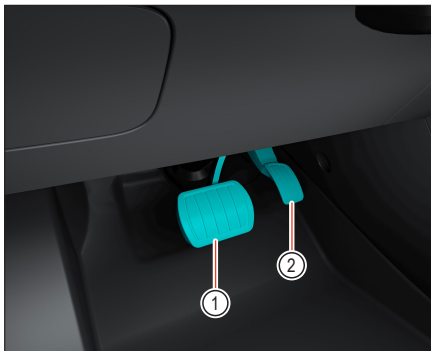

Pedal Area

- ① Brake Pedal
- ② Accelerator Pedal

CAUTION

Before driving, ensure that all pedals can be easily depressed to the fullest extent and automatically return to their original position at any time.

WARNING

- Do not drive wearing high heels or slippers. High heels may prevent the brake pedal from being fully depressed. Wearing slippers may lead to slipping off the brake pedal, failing to apply maximum braking force in time, and potentially causing accidents.
- Do not place items like drink bottles or cans in the storage box of the central console, as they may roll out during emergency braking or bumps, obstructing the operation of the brake and accelerator pedals, leading to serious accidents.
- If the brake pedal does not return to its normal position, contact a dealership for a brake system inspection.

Checking the Brake Pedal

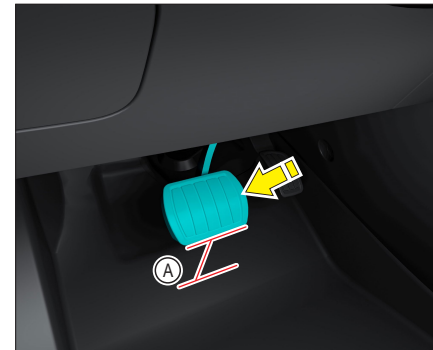

After powering up the vehicle, check the distance A between the initial position of the pedal and the carpet (A). Contact a dealership if the distance is not within the following range:

Distance (A): 143.9±6mm

Brake Pedal Free Travel: 5~20mm

Pedal Force: ≤ 500N

Driving Guide

Vehicle Start-Up



1. Carry the smart key, unlock and open the driver's door, and the vehicle can be powered on.
2. After powering up, close the driver's door and fasten the seatbelt.
3. Press down on the brake pedal, the vehicle starts and enters READY status, and the Instrument cluster **READY** indicator light illuminates.

Emergency Vehicle Start-Up



When the smart key battery is low, place the smart key in the emergency start area (as shown) with all doors closed, depress the brake pedal to start the vehicle in an emergency.

Vehicle Shutdown

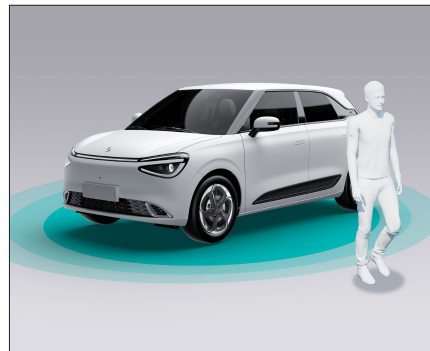

1. After stopping the vehicle, press the P gear button to switch to P gear, and the electronic parking brake will be automatically engaged.
2. Unfasten the driver's seatbelt and open the driver's door to exit the READY state.
3. After leaving the vehicle, lock the doors from outside to automatically power down the vehicle.

Vehicle Power-Off Switch*



Models with a physical power-off switch: Long press the power-off switch on the left side of the dashboard to power down the vehicle.

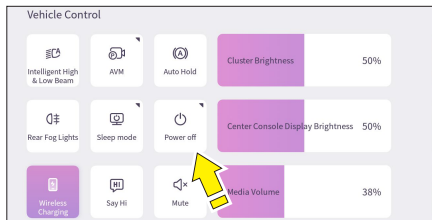

Models without a physical power-off switch: Pull down the negative one-screen interface on the MP5 and press the power-off soft switch to power down the vehicle.

Electronic Gearshift Operation Instructions



Gearshift Control

After the READY indicator on the combination instrument panel is illuminated, depress the brake pedal and toggle the electronic gearshift up or down to switch gears.

Gears

The vehicle has four gears: P, R, N, D.

P Gear: Parking Gear

Switch to this gear when the vehicle needs to be parked.

With the vehicle stationary, depress the brake pedal and press the P gear button at the end of the electronic gearshift lever. The vehicle enters P gear, and "P" is displayed on the instrument panel.

-112-

R Gear: Reverse Gear

Switch to this gear when the vehicle needs to reverse.

With the vehicle stationary, depress the brake pedal and push the electronic gearshift lever upwards. The vehicle enters R gear, and "R" is displayed on the instrument panel.

N Gear: Neutral Gear

Switch to this gear for a temporary stop, with "N" displayed on the instrument panel.

- In D gear, push the electronic gearshift lever up one gear.
- In R gear, push the electronic gearshift lever down one gear.
- In P gear, depress the brake pedal and push the electronic gearshift lever up or down one gear.

D Gear: Drive Gear

Switch to this gear when the vehicle needs to move forward.

With the vehicle stationary, depress the brake pedal and push the electronic gearshift lever down two gears. The vehicle enters D gear, and "D" is displayed on the instrument panel.

Gear Display

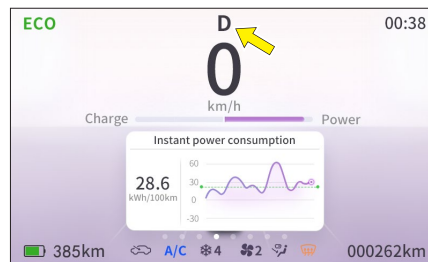

CAUTION

- When the conditions for switching gears are not met, the gear display on the instrument panel flashes with corresponding prompt messages. Follow the prompts for operation.
- Switch to P or R gear only when the vehicle is stationary.
- When the gear is in R/N/D, press the P gear button to switch to P gear.
- When the READY indicator on the combination instrument panel is illuminated, all gears can be switched; when it is not illuminated, only P and N gears can be switched.
- Do not coast in neutral while driving, as it may damage the vehicle or cause danger.

Driving Modes*

Mode Switching



Models without MP5: Press the driving mode button on the left side of the multifunction steering wheel to switch driving modes. There are three modes: Economy mode, Comfort mode, Sport mode.

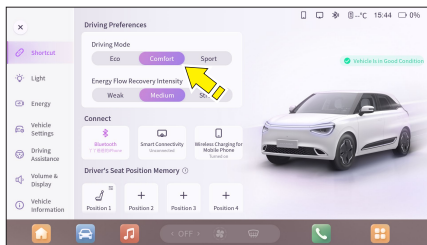

Models with MP5: Set the driving mode in the MP5 Quick → Driving Preferences interface. There are three modes: Economy mode (green), Comfort mode (purple), Sport mode (red).

Instrument Panel Display

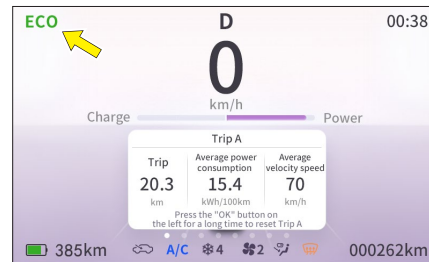

The driving mode can be viewed in the upper left corner of the combination instrument panel.

3

When Driving

Driving Guide

Energy Recovery*

Models with MP5: Set the intensity of energy recovery in the MP5 Quick → Driving Preferences interface. The vehicle recovers energy (weak, medium, strong) during braking and coasting, recharging the power battery.

Models without MP5: The intensity of energy recovery (weak, medium, strong) changes synchronously with the driving mode (Economy mode, Comfort mode, Sport mode).

CAUTION

- Choose the driving mode according to your driving habits. Too strong energy recovery can affect the driving experience. When releasing the accelerator pedal, you may noticeably feel the vehicle slowing down. This is normal, indicating that the drive motor is charging the power battery through regenerative braking, achieving energy recovery.
- On icy roads, for your safety, choose weak energy recovery and drive cautiously.
- When the power battery is fully charged, it will not enter energy recovery mode. Energy recovery can be resumed once a certain amount of charge is consumed.

Low-Speed Warning Sound

When the vehicle is moving at low speed, the low-speed warning sound alerts pedestrians nearby for safety.

CAUTION

- If the low-speed warning sound is not audible while driving at low speed, immediately open the window, activate the hazard warning lights, drive at a steady low speed, and check the sound effect. If the warning sound is still not audible, contact a dealership.

3

When Driving

Safe Parking

Park the vehicle in a safe, flat area. The correct parking method can ensure the vehicle is secured to prevent unintended movement:

1. Stop the vehicle, switch the electronic gearshift to "P" gear, activate the parking brake, and ensure the parking brake is reliable.
2. Ensure all lights and electrical devices are turned off. Ensure all windows are closed, and all doors are locked.
3. When parking on a slope, always turn the front wheels towards the curb.
4. When parking on a slope with an empty vehicle, use wheel chocks or similar items to secure the front wheels; if the vehicle is loaded, secure the rear wheels as well.

Parking on downhill roads with curb

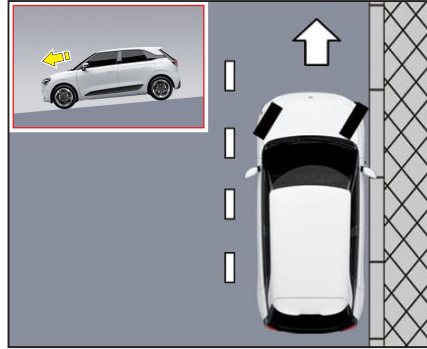

Turn the steering wheel in the direction of the curb and let the vehicle forward until the wheels on the curbside touch the curb gently.

Parking on uphill roads with curb

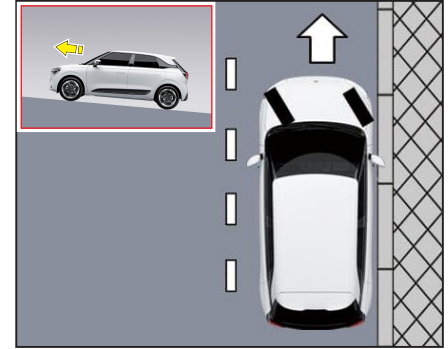

Turn the steering wheel away from the curb and move the vehicle backward until the wheel on the curb side touches the curb gently.

Driving Guide

Parking on slopes without curb

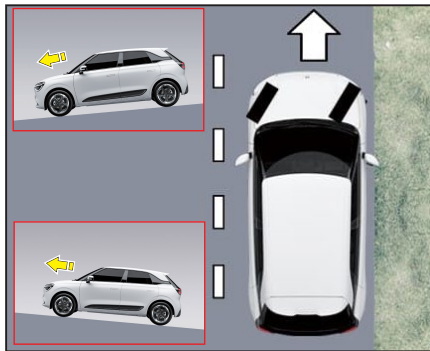

Turn the wheels to the side of the road to prevent the vehicle from moving towards the center of the road.

Parking safety matters

⚠ WARNING

- Do not park vehicles near inflammable and explosive materials, so as not to cause fire.
- When parking, the parking brake must be activated and the EPB parking indicator light in the instrument cluster must be confirmed (P) Light up.
- When the driver leaves the vehicle, make sure that the vehicle is powered off and carry the vehicle key with him. Otherwise, people who stay in the car may start the vehicle by mistake or turn on electrical equipment, causing serious accidents.
- Never leave children or people in need of care alone in the car! Otherwise, it may cause suffocation or unintentional movement of vehicles and serious accidents.

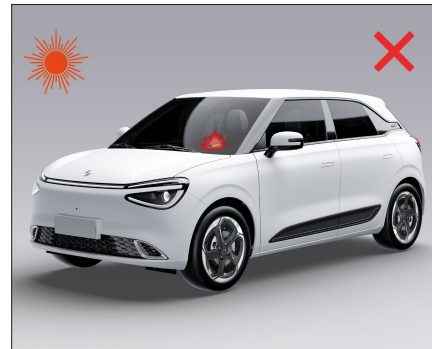

⚠ WARNING

- Do not store inflammable and explosive materials in the car, such as gas lighters, matches, wax spray cans on the dashboard, etc. Under the sun's exposure, it may explode and lead to fire.
- Do not store bottled or bottled carbonated drinks, beer, white wine, etc. in the car, especially in hot summer, so as to avoid explosion caused by heat.
- Do not place mineral water bottles and glasses filled with water on the dashboard, so as to avoid local high temperature fire caused by sunlight.



⚠ WARNING

Never park the vehicle on flammable materials such as dead leaves or hay, because the temperature of driving motor and other components will rise after driving for a long time. If there are flammable materials under the vehicle, it is likely to cause fire.

The Electric Power Steering (EPS) system provides steering assistance during vehicle maneuvering based on various driving conditions, including vehicle speed (greater assistance at lower speeds and reduced assistance at higher speeds) and the rate at which the steering wheel is turned. This system not only eases steering effort during low-speed maneuvers but also significantly enhances handling stability at higher speeds.

During parking or extremely low-speed driving, if the steering wheel is operated repeatedly and continuously, the EPS system will reduce the steering assistance to prevent system overheating. This makes the steering wheel more difficult to turn. If such operation continues, the electric power steering system will enter an overheating protection mode, gradually reducing the assistance provided, making the steering wheel increasingly difficult to turn, especially during parking or low-speed driving. Once the temperature of the electric power steering system decreases, the assistance will return to normal.

Brake System Description

Vehicles equipped with vacuum-assisted brakes use a vacuum pump to provide a vacuum source to the brake booster, increasing braking force.

If the vacuum pump stops supplying power, the brake assist will not work, requiring more force to depress the brake pedal and increasing the stopping distance.

Factors affecting braking effect

1. Wear

Brake pad wear depends to a great extent on the use conditions and driving mode, especially for those vehicles that often travel in urban traffic and short distances or drive in sports mode. Therefore, it is necessary to check the thickness of brake pads within the specified time interval of maintenance.

2. Wet or Salt-sprinkled road

Wet road:When driving in accumulated water or heavy rain, or after washing the car, the brake disc and brake pad will be wet or freeze at low temperature in winter, and the braking efficiency will be reduced.It is necessary to lightly press the brake pedal several times to dry the brake and restore its performance.

Salt-sprinkled road:When driving on salt-sprinkled road, if the brake is not used for a long time, there will be salt layer on the brake disc and brake pad, and the braking efficiency will be reduced.It is necessary to lightly step on the brake pedal several times to remove the salt layer on the brake disc and brake pad.

3. Mountainous environment

Because of the high mountain and long slope, the brakes are used frequently and for a long time, and often work continuously under high-intensity braking conditions, these factors will make the braking efficiency worse. Therefore, when the vehicle goes downhill, do not slide in neutral and avoid frequent braking.

4. Icy and snowy weather

Due to the low friction coefficient of ice and snow road surface, the braking distance will be greatly prolonged during braking, and the braking distance will increase with the increase of vehicle speed.Therefore, special attention should be paid to controlling the vehicle speed when driving on ice and snow road surface, and a large safe distance should be kept from the front vehicle and lateral vehicle.

5. Surface rust on brake discs

If the vehicle is parked for a long time, the brake disc may be corroded and the brake pads may be fouled. It is recommended that you drive at low speed and brake several times to clean the brake disc before driving formally.

6. Brake system fault

If you notice a sudden increase in braking distance or a longer brake pedal stroke, there may be a brake system failure. The driving style should be adjusted to ensure safety, and more force should be applied to the brake pedal when braking, and the driving speed should be low to the nearest franchise store.

WARNING

When the vehicle completely loses its braking, do not drive by force.At this time, pull over safely and contact the franchise store to wait for rescue.

7. Brake overheating

Do not place your feet on the brake pedal when braking is not needed. This will cause the brake to overheat, reduce braking efficiency, extend braking distance, and increase brake pad and brake disc wear.

Brake wear indicator

The brake pad is equipped with a wear sound reminder. If you hear harsh screams or scratches when you step on the brake during driving (this is different from brake squeezing, which is usually caused by dust on the brake surface during slight braking), it indicates that you need to replace the brake pads.

CAUTION

- Vehicle operation in high-altitude areas may result in a heavier pedal feel due to reduced atmospheric pressure. Please exercise caution while driving.
- When the vehicle is running normally, don't habitually put your feet on the brake pedal, which will inadvertently press the brake pedal and cause the brake to overheat, which will reduce the efficiency of the brake, shorten the service life of the brake pads and increase the power consumption of the vehicle. The brake lights are always on, which will also cause the rear driver to misjudge the road conditions ahead.
- When going down a long slope, the continuous use of the brake will make it accumulate heat, thus reducing the efficiency of the brake.
- After wading, the vehicle must check the braking effect, press the brake pedal moderately, and feel whether the braking is normal. If there is any abnormality, under the condition of ensuring safety, the brake pedal can be lightly pressed frequently to dry the brake until it returns to normal.
- When driving, make sure to keep enough distance from other vehicles to ensure enough reaction time and braking distance during emergency braking.

Hydraulic Brake System

The hydraulic brake system transmits hydraulic pressure to the brake through double circuits. If one of the circuits fails, the other circuit will continue to work. At this time, under the condition of ensuring safety, drive to the nearest franchise store for maintenance at low speed. In this case, more force should be applied to the pedal for braking.

If the brake system fails, the warning light  Light up during driving, indicating that the brake system is faulty, and the brake fluid level needs to be checked at this time. If the brake fluid level is normal, there are other faults in the brake system. At this time, under the condition of ensuring safety, pull over immediately, and contact the franchise store for inspection and maintenance.

Brake System

Anti-lock Brake System(ABS)

ABS anti-lock braking system can prevent the wheels from locking during braking, which helps the driver to better control the direction of the vehicle during braking and reduces the sideslip phenomenon when the vehicle brakes on slippery roads.

Working Mode of ABS Anti-lock Braking System

When the ABS system works, you can feel the brake pedal shaking and hear the "clicking" sound at the same time, which is a normal phenomenon and does not mean that there is a fault.

During emergency braking, the brake pedal must not be released before the vehicle stops or is out of danger (this is very important!) The brake pedal should not be pressed repeatedly, which will stop the ABS and may increase the braking distance.

If the road is slippery, the ABS system will be activated even if the brake pedal is lightly pedaled, so that the driver can obtain the road characteristic information through braking and then adjust his driving mode.

CAUTION

- The function of ABS anti-lock braking system has some limitations. Developing good driving habits is the basic guarantee of safe driving. Don't take it lightly when driving because you are equipped with ABS system.
- In order to obtain the shortest possible braking distance and braking stability, the brake pedal should be pressed as hard as possible.
- After the failure of ABS system, the conventional braking system of the vehicle can still work normally, but without the anti-lock braking function of wheels, the braking distance may be longer accordingly.

ABS Malfunction Warning Light

If the ABS Malfunction Light  is lit during driving, it means that the brake system is faulty, and at this time, it should be driven at a low speed to the nearest franchise store for maintenance.

Electronic Brakeforce Distribution System (EBD)

EBD Electronic Brakeforce Distribution System automatically adjusts the braking force distribution ratio of front and rear axles, improves braking efficiency, shortens braking distance to a certain extent, and improves braking stability with ABS.

Brake Assist System(BA)

BA brake assist system can assist braking during emergency braking. When the driver steps on the brake pedal quickly in an emergency, but the pedal force is insufficient, the system will automatically increase the braking force, thus shortening the braking distance.

Electronic Stability Control System (ESC)

ESC electronic stability system can improve the driving stability of vehicles, for example, when accelerating and driving in corners, it can reduce the risk of sideslip of vehicles.

In special circumstances, the ESC function should be removed, such as:

- When the vehicle is equipped with snow chains.
- When the vehicle is driving in deep snow or on soft roads.
- When the vehicle is stuck in muddy road and needs to move back and forth.

CAUTION

Electronic Stability Control System (ESC) has some limitations on vehicle driving stability control. Even if the vehicle is equipped with ESC, the driving mode should be adjusted at any time according to road conditions and traffic conditions. This is especially important for driving on smooth and wet roads. Please don't risk driving because this system improves the stability of the vehicle, otherwise there will be the danger of accidents!

ESC function activation

This function is automatically activated every time the vehicle is powered on, and the system starts working in case of traction or adhesion problems. When this function works, the ESC fault warning light on the combined instrument  blinks.

ESC function disabled

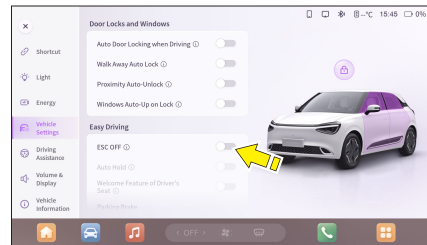



Under certain conditions (the vehicle starts in sand, snow or soft road), the convenient driving interface on MP5 vehicle can be set, and the ESC function is turned off, and the ESC turn-off indicator light on the instrument cluster can be set  Will light up.

The ESC function is disabled and restored again

The ESC function can be restored after the function is turned off in any of the following ways:

- After re-powering, ESC will automatically resume.
- Press the ESC function OFF (OFF) switch again to turn on the ESC function, and the ESC OFF indicator light on the instrument cluster  Will go out.

ESC function failure

When the vehicle is running normally, if the ESC fault warning light on the instrument cluster  Constantly on, ESC turn off indicator light  When it is not lit, it indicates ESC failure. Please go to the franchise store for inspection or repair.

Brake System

Parking Brake System

Enable/Disengage electronic parking brake

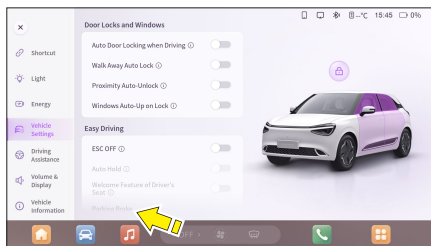

Electronic parking brake indicator light

EPB Parking Indicator (P) Red lights up, indicating that EPB has been enabled.

EPB fault indicator (P) Yellow light indicates that EPB is faulty and parking brake will not work. Please contact the franchise store for inspection and maintenance.

Dynamic Emergency Braking

If the vehicle's service brakes fail, pressing and holding the P gear button activates dynamic emergency braking.

Releasing the P gear button exits dynamic emergency braking.

CAUTION

If there is a persistent burning smell or noise after dynamic emergency braking, the system may have failed. Contact a dealership.

Engage the electronic parking brake	Manual	After the vehicle stops: -Press the P gear button. -On some models, touch the parking icon on the MP5 interface. -On some models, long press the steering wheel OK button on the instrument EPB interface to engage.
	Automatic	The EPB engages automatically when the vehicle is powered down.
Release the electronic parking brake	Manual	After the vehicle stops, press the brake pedal.
	Automatic	After the vehicle enters READY status, close the doors, and shift from P to another gear on flat ground or a gentle slope.

Automatic Parking (Auto Hold)*

The Auto Hold function allows the vehicle to remain stationary during brief stops without continuously depressing the brake pedal.

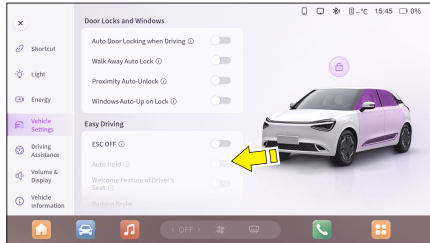

Activate or deactivate Auto Hold in the MP5 vehicle settings → convenience driving interface.

The green Auto Hold indicator light signifies that the system is active.

⚠ WARNING

- Auto Hold is not a substitute for the driver's responsibility to park the vehicle. Always be aware of the vehicle's parking status.
- Do not use Auto Hold when the vehicle is being towed or entering an automatic car wash.

👁 CAUTION

Use the EPB for long-term parking by engaging P gear.

Driving Assistance

Forward Collision Warning (FCW)*

The Forward Collision Warning (FCW) function detects the relative speed and distance between your vehicle and the vehicle ahead, as well as pedestrians crossing the road, using the front-view intelligent driving camera mounted on the front windshield.

When a collision risk is present, the vehicle emits audio and visual warnings, alerting the driver to brake and avoid a collision.

Operating Conditions:

- For vehicles traveling in the same direction, the warning speed of your vehicle ranges from 5 to 130 km/h.
- For pedestrians or stationary targets, the warning speed of your vehicle ranges from 5 to 60 km/h.
- The maximum detection distance is 140 meters.

Function Settings

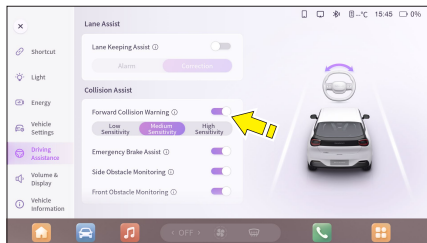

The Forward Collision Warning Assistance can be turned on/off in the MP5 assisted driving → collision assistance interface. The sensitivity of the warning (low, medium, high) can also be set.

Low indicates the latest warning time, medium indicates a moderate warning time, and high indicates the earliest warning time.

Warning Method

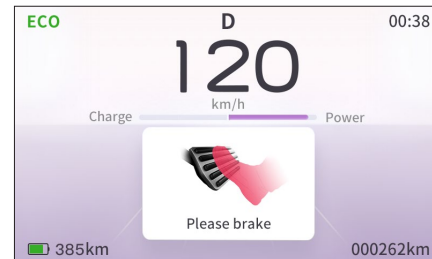

When there is a collision risk ahead, the vehicle will issue an urgent warning, the combination instrument indicator light  flashes with a pop-up "Please press the brake pedal," accompanied by a buzzer sound alarm reminder.

Indicator Lights

When the Forward Collision Warning Assistance FCW is off, the indicator light  illuminates in yellow.

If the Forward Collision Warning Assistance FCW fault warning light  illuminates in yellow while the vehicle is driving, it indicates a system malfunction. Please go to an authorized dealership for inspection or repair immediately.

Autonomous Emergency Braking (AEB)*

Autonomous Emergency Braking (AEB) function detects the relative speed and distance between your vehicle and the vehicle ahead, as well as pedestrians crossing the road, using the intelligent driving camera mounted on the front windshield.

When a collision risk is present, the vehicle emits audio and visual warnings. If the driver still does not brake, the system will automatically perform emergency braking. If the driver brakes but the braking force is insufficient, the system will prepare for braking, either partially or fully, to avoid or mitigate the collision.

Operating Conditions:

- Audio and visual warnings when your vehicle's speed is between 5 and 130 km/h.
- Maximum detection distance for audio and visual warnings is 140 meters.
- Recognizes pedestrians over 80 cm in height.
- For vehicles traveling in the same direction, your vehicle's speed needs to be between 5 and 85 km/h.
- For vehicles crossing the path, your vehicle's speed should be between 5 and 60 km/h.
- The maximum speed reduction during automatic braking is 60 km/h.

Braking Preparation

The AEB system prepares for emergency braking by automatically reducing the gap between the brake caliper and the brake disc. This process may produce a slight braking sensation.

Visual and Auditory Alarms

When the AEB system detects a potential collision, it triggers a collision warning, emitting visual and auditory alarms to prompt the driver to take timely measures, maintain a safe distance, and avoid collisions.

Autonomous Emergency Braking

When the driver applies insufficient braking force or no braking at all, and the AEB system detects a continuing collision risk, the function intervenes to perform automatic braking. Concurrently, the vehicle emits visual and auditory warnings to avoid a collision or significantly reduce the collision speed.

For this function, the vehicle's speed should be between 5 and 85 km/h for vehicles traveling in the same direction, and between 5 and 60 km/h for crossing vehicles. The maximum speed reduction during automatic braking is 60 km/h.

Scenarios Where AEB Should be Disabled:

- When the vehicle is being towed.
- When entering an automatic car wash.
- When temporary attachments or other objects cover the front-view intelligent driving camera.
- When driving off-road or on a racetrack.
- When driving on continuous winding mountain roads.
- When installing anti-skid chains.
- In adverse weather conditions, such as heavy rain, snow, or hail.

 **CAUTION**

- Drivers should not overly rely on the AEB function, should not intentionally test it, or wait for it to trigger. Situations where the function fails to trigger or triggers erroneously due to limitations are unavoidable.
- The AEB function is effective only for vehicles traveling in the same direction and pedestrians crossing the road. It does not work for obstacles including but not limited to electric bikes, bicycles, motorcycles, animals, trash cans, boxes, walls, etc.
- It cannot recognize pedestrians shorter than 0.8 meters.

CAUTION

- The AEB function cannot recognize all pedestrians in all situations, such as partially obscured pedestrians or those carrying large objects.
- The AEB system will not work for vehicles or pedestrians crossing the driving lane or coming head-on in the same lane, or for pedestrians on two-wheel or three-wheel vehicles.
- In adverse weather conditions (such as heavy rain, snow, hail, etc.), camera monitoring functions are limited.
- When the camera is dirty or covered, its detection capability is disturbed, leading to reduced performance.
- The AEB function is designed to enhance driving safety. It cannot cope with all the conditions of roads, traffic, and weather.
- The camera's detection function is limited in cases where the vehicle has collided, experienced severe vibrations, or any other situation that could change the camera's position, limiting AEB performance.
- When the camera's internal temperature is too high, AEB performance is limited.
- If the camera inside the front windshield fogs up, AEB functionality is limited.

CAUTION

- When driving on curves, the AEB function might misidentify vehicles in other lanes as being in front or fail to detect vehicles in the same lane, leading to unexpected braking or failure to brake in time. Drivers should maintain a safe driving distance and be ready to take action or brake.
- When other vehicles have add-ons or loads extending to the side, back, or top beyond the vehicle's edge, the AEB function may not work.
- The vehicle may brake when passing under low bridges or height limit bars.
- The vehicle may brake when passing over speed bumps, metal plates, approaching railway tracks, or roadside objects (such as barriers, transformers, traffic signs).

Function Settings

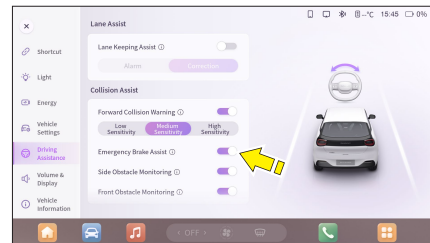

The Emergency Collision Assistance function can be turned on/off in the MP5 assisted driving → collision assistance interface.

When the Forward Collision Warning Assistance is turned off, the Emergency Collision Assistance function cannot be activated.



Indicator Lights

When the Autonomous Emergency Braking(AEB) is off, the indicator light  illuminates in yellow.

If the Autonomous Emergency Braking(AEB) fault warning light  illuminates in yellow while the vehicle is in motion, it indicates a system malfunction. Please go to an authorized dealership for inspection or repair immediately.

 CAUTION

The AEB system will not operate in the following situations:

- When the fault warning light  or the off indicator light  on the combination instrument panel illuminates in yellow;
- When the ESC system is faulty or active (triggered by driving on bumpy or slippery surfaces);
- When the vehicle is in reverse;
- When the accelerator pedal is pressed more than 85% of its travel distance;
- During rapid acceleration, sharp turns, or quick steering corrections;
- For vehicles coming head-on in the same lane;
- When the driver's seat belt is not fastened;
- When the driver's door is open;
- When the windshield wiper is operating at high speed;
- In case of faults with the vehicle speed, accelerator pedal, or brake pedal sensors;
- When the perception system is faulty;
- When the vehicle speed reduction caused by a single AEB emergency braking event reaches 50 km/h;
- Within 10 seconds after the last AEB emergency braking event.

Lane Keeping Assistance*

Lane Keeping Assistance includes Lane Departure Warning (LDW) and Lane Keeping Assist (LKA) functions. It uses the front-view intelligent driving camera mounted on the front windshield to detect lane markings and calculate the vehicle's actual position (driving trajectory) within the lane.

When the LDW function is activated, and the vehicle is traveling at medium or high speeds, the system alerts the driver with sound and instrument display notifications if the vehicle is about to deviate from its lane.

When the LKA function is activated, and the vehicle is traveling at medium or high speeds, the system applies steering force to assist the vehicle in staying within its current lane, reducing the driver's steering burden and enhancing driving comfort and safety.

Operating Conditions:

- Vehicle speed between 60 and 140 km/h.

 CAUTION

- The Lane Keeping Assistance system is only a tool to assist the driver and cannot replace cautious driving and judgment. The driver must always maintain control of the vehicle and is fully responsible for it.
- The system's performance may decline due to environmental impacts (such as heavy rain, fog, snow, backlighting affecting camera performance) or due to the target's own characteristics.
- Do not change the position of the front-view camera arbitrarily. Strong vibrations or minor impacts can affect the camera's performance. Regularly clean the upper part of the front windshield to keep the camera clear.
- During the use of the vehicle, do not obstruct the camera's field of vision. Dirt on the windshield within the camera's view can prevent the corresponding functions from operating effectively.
- Do not tint the vehicle's front windshield or add non-standard coatings. Any items that obstruct the system camera's view can affect the system's normal operation.

Driving Assistance

Lane Departure Warning (LDW)*

Through the MP5 settings, the Lane Departure Warning (LDW) function can be activated. In the absence of faults, the Lane Departure Warning status indicator light  (green) will illuminate.

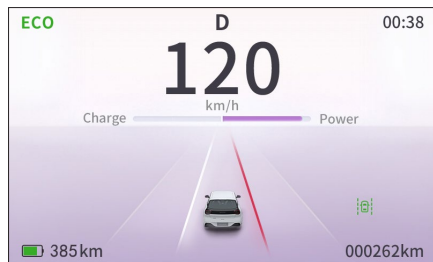

(green) will illuminate.

If the camera located at the top of the front windshield detects the vehicle deviating from its driving lane and the function's conditions are met, the Lane Departure Warning (LDW) will alert the driver through an alarm, with the deviating side lane line highlighted in red and accompanied by an auditory warning.

Activation Conditions of the Function

The Lane Departure Warning (LDW) can be used under the following conditions:

- Both sides of the current driving lane, or entering a single side, have detectable lane markings, curbs, shoulders, and other road information.
- Vehicle speed is between 60 and 140 km/h.
- Driving on straight or slightly curved roads.
- Turn signals and hazard lights are not activated;
- The vehicle is in D gear.
- Vehicle is driving smoothly, and the driver is not making large, fast, or strong steering wheel movements.

Function Settings

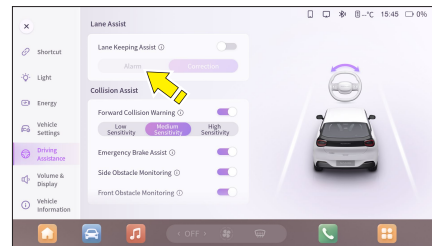

The Lane Keeping Assistance function can be turned on/off in the MP5 assisted driving → lane assistance interface.

Selecting 'Alarm' can activate the LDW function alone and turn off the LKA function. After selection, the lane lines on the instrument panel will turn gray and display in white when working conditions are met.

Function Malfunction

If the Lane Departure Warning malfunction warning light  (red) illuminates while the vehicle is driving normally, it indicates a malfunction in the LDW function, and the function will not operate.

If the warning light still illuminates after restarting the vehicle, driving for a while, and allowing the system to self-learn, contact an authorized dealership for repair as soon as possible.

 CAUTION

- After disconnecting the vehicle's battery cable, if the Lane Departure Warning function was previously set in the MP5 display, the Lane Departure Warning malfunction warning light  might illuminate. In this case, drive the vehicle for a while to allow the system to self-learn, after which the fault light should disappear.
- The Lane Departure Warning system is an auxiliary system and cannot actively control your vehicle to change or maintain lanes. You are responsible for always checking road conditions and controlling the vehicle.
- Avoid subjecting the system camera to strong impacts, moisture, or heat, and refrain from disassembling parts on your own.
- To ensure normal operation of the system, keep the outside top surface of the windshield glass free of dirt, ice, snow, or any other obstructions.
- Do not tint the vehicle's front windshield or add non-standard coatings. Any items that obstruct the system camera's view can affect the system's normal operation.
- If the system camera cannot detect lane information due to external environmental influences, or if the activation conditions are not met, and the vehicle deviates from the lane, the system will not take any action.

 CAUTION

- The sound of the vehicle's audio system or external noise may prevent you from hearing the warning buzzer. Try to minimize these sounds and focus on observing road conditions.
- When passing through complex lane sections (intersections, sudden changes in lane markings, lane convergence, etc.), there may be situations where lane information is temporarily undetectable. Always maintain control of the vehicle.

Driving Assistance

Lane Keeping Assist (LKA)*

Through the MP5 settings, the Lane Keeping Assist (LKA) function can be activated. In the absence of faults, the Lane Keeping Assist status indicator light  (green) will illuminate.

If the camera located at the top of the front windshield detects the vehicle deviating from its lane, and the function's conditions are met, the Lane Keeping Assist (LKA) applies a counter-steering torque to assist the driver in keeping the vehicle within the normal driving lane.

Activation Conditions of the Function

The Lane Keeping Assist (LKA) can be used under the following conditions:

- Detectable lane markings on both sides of the current driving lane or on one side, with the vehicle positioned in the middle of the road;
- Vehicle speed is between 60 and 140 km/h.
- Driving on straight or slightly curved roads;
- Lane width 2.5 to 4.4 meters;
- Turn signals and hazard lights are not activated;
- The vehicle is in D gear.
- Vehicle is driving smoothly, and the driver is not making large, fast, or strong steering wheel movements.

i NOTE

When changing lanes without using the turn signal, the Lane Keeping Assist (LKA) function may be activated, applying steering torque. To change lanes normally, please use the turn signal.

Function Settings

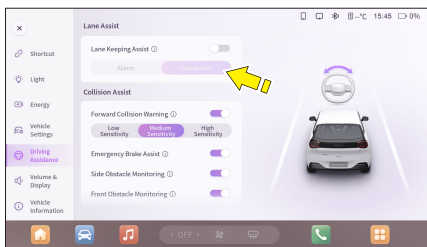

The Lane Keeping Assistance function can be turned on/off in the MP5 assisted driving → lane assistance interface.

Selecting 'Correction' can activate both the LDW and LKA functions. After selection, the lane lines on the instrument panel will turn gray and display in white when working conditions are met.

Function Status Explanation

When the Lane Keeping Assist function is activated through the MP5 settings, in the absence of faults, the Lane Keeping Assist status indicator light  (green) will illuminate. When the vehicle deviates from the lane, and the LKA system is working, the respective intervention side lane line turns blue.

The system will issue an alarm (including an alarm interface and sound) and apply steering torque to assist the driver in correcting the driving trajectory in the following situation:

- When the system can detect lane lines, and the vehicle is driving on the edge of the lane

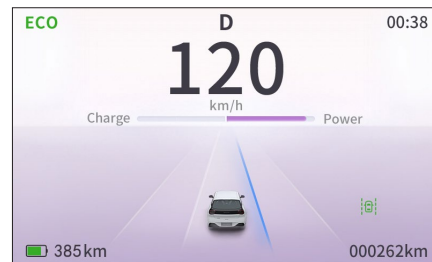

line, at risk of deviating from the lane, and without using the turn signal, the respective intervention side lane line turns blue.

- When the driver's hands are not on the steering wheel for a certain period, starting from the second self-correction by the system, the instrument panel will prompt to keep

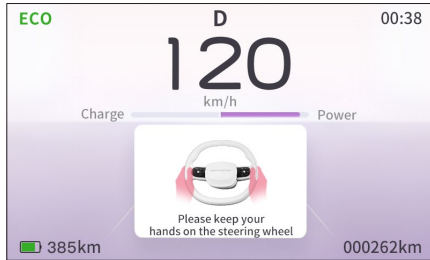

hands on the steering wheel, accompanied by a buzzer alarm. If the driver continues not to take over, the alarm will persist, but the function will not exit.

Function Malfunction

If the Lane Keeping Assist malfunction warning light  (red) illuminates while the vehicle is driving normally, it indicates a malfunction in the LKA function, and the function will not operate.

If the warning light still illuminates after restarting the vehicle, driving for a while, and allowing the system to self-learn, contact an authorized dealership for repair as soon as possible.

CAUTION

- After disconnecting the vehicle's battery cable, if the Lane Keeping Assist function was previously set in the MP5 display, the Lane Keeping Assist malfunction warning light  might illuminate. In this case, drive the vehicle for a while to allow the system to self-learn, after which the fault light should disappear.
- Always keep both hands on the steering wheel and be ready to steer. The driver must drive along the correct lane.
- The Lane Keeping Assist system might interpret road markings as lane information (e.g., zebra crossings, poor road surfaces, cobblestone roads). Always maintain control of the vehicle or turn off the function.
- In more complex lane sections (intersections, sudden changes in lane markings, lane convergence, etc.), there may be situations where lane information is temporarily undetectable. Always maintain control of the vehicle.

Driving Assistance

Activation and Deactivation of the Function

After the feature is activated, the LDW/LKA system automatically engages when the vehicle speed exceeds 60 km/h; the LDW/LKA system disengages when the vehicle speed drops below 55 km/h.

Factors Limiting the Function

Even if the Lane Keeping Assist function is activated and operational, the system may be affected or not work under the following conditions:

- Poor visibility, such as in rain, fog, or snow;
- Obstructions in front of the camera.
- High temperatures around the camera due to direct sunlight.
- Glare caused by direct sunlight, oncoming traffic, reflections from wet roads, etc.
- Sudden changes in outdoor brightness, such as when entering/exiting tunnels.
- Low light conditions at night or inside tunnels without the front headlights on.
- Absence of lane markings or difficulty distinguishing lane marking colors from the road surface.
- Unclear or non-standard lane markings.
- Lanes that are too wide, too narrow, or have sharp curves.

- Increase or decrease in the number of lanes or complex lane markings.
- More than two lane markings on either side of the vehicle's path.
- Road markings or objects resembling lane markings.
- Shadows cast on lane markings by barriers or other objects.
- Short-term changing markings, such as on ramps or highway exits.
- Other situations that may affect the camera's correct identification of lane information or the system's control of steering.

Adaptive Cruise Control (ACC)*

The Adaptive Cruise Control (ACC) feature is an advanced driver assistance system that actively controls vehicle speed. Building upon traditional cruise control, it utilizes camera sensors to monitor the vehicle ahead, automatically adjusting the driving speed of the car for automatic cruise following. According to whether the system identifies a target vehicle, it can automatically switch between constant speed cruise control and following cruise control. ACC also actively controls the vehicle speed in curves to enhance safety.

The vehicle's cruising speed and the time distance from the vehicle ahead can be set using the cruise control buttons on the steering wheel. The vehicle can be set to cruise at a fixed speed in the range of 30~140 km/h or to follow the vehicle ahead at speeds from 0~140 km/h, including automatic stopping when following a leading vehicle.

ACC System Activation Conditions

- Vehicle speed between 0~140km/h.
- READY light is on.
- Electronic Parking Brake (EPB) is released.
- Vehicle gear is in D.
- No rollback in the vehicle.
- All doors, tailgate, and hood are closed.
- Driver's side seat belt is fastened.
- Wipers are not in high-speed mode.
- ECS is on, and the ESC off indicator on the instrument cluster is not illuminated.
- When the vehicle is not stationary, the brake pedal is not pressed.
- The front-view intelligent driving camera is not faulty.
- ACC malfunction warning light  is not illuminated;
- No other ACC system inhibiting conditions are present.

CAUTION

- The ACC system is a driving assistance system designed to enhance driving comfort but is not a substitute for the driver. Even when the ACC system is activated, the driver must drive cautiously, always maintain control of the vehicle, and adhere to traffic rules.
- Pressing the brake pedal while driving will immediately deactivate the ACC system.
- In certain situations (e.g., when the relative speed of the vehicle ahead is too high, sudden lane changes, or too small a safety distance), the system may not have enough time to reduce relative speed. In such cases, the driver must react promptly.
- When the ACC system is operational, and the driver presses the accelerator pedal, the vehicle will be under the driver's control. The ACC system's distance control function will not be activated.
- The ACC system does not detect vehicles coming head-on in the same lane.
- The ACC system is suitable for use on highways and well-conditioned roads with good weather, not for complex urban roads, mountain roads, ramps, tunnel entrances/exits, or inside tunnels.

- The ACC system recognizes motor vehicles such as cars and trucks for adaptive cruising but cannot identify pedestrians, other road obstacles, crossing vehicles, or special-shaped vehicles for adaptive cruising.
- When entering and exiting curves, target selection may be delayed or interfered with. The ACC system may not brake as expected or brake too late in these situations.
- If the vehicle is too close to the adjacent lane (or a vehicle in the adjacent lane is too close to your lane), the system may react to the adjacent vehicle and brake.
- If a vehicle changes lanes into the path of your vehicle within the detection range of the ACC system, that vehicle will be recognized as a target, and the system will react, possibly causing strong braking or delayed braking. The driver should take over the vehicle promptly to avoid accidents.
- Do not change the position of the front-view camera. If the camera's position is altered due to a collision, contact an authorized dealership.

- In conditions such as heavy rain, snow, fog, strong reflections on wet roads at night, or intense glare from direct sunlight, the camera sensor's detection may be interfered with, limiting functionality. In such cases, activating the ACC system may indicate that activation conditions are not met, or it may prompt the driver to take over after activation.
- In rare cases during the process of stopping behind a leading vehicle, the system may not recognize the vehicle's rear end but instead recognize the lower end of the target (e.g., the rear axle of a high-chassis truck or the vehicle's bumper). The system cannot guarantee an appropriate stopping distance, and the driver must remain alert and ready to brake.
- Due to physical limitations, the ACC system cannot guarantee safe and reliable operation in all conditions. If you have any questions about the function, please contact an authorized dealership.
- Sensors that are dirty or covered can limit vehicle recognition. Do not cover the sensor detection area and keep the windshield area around the rearview mirror clean.

WARNING

- The system may request to exit the function when faced with complex traffic scenarios that it cannot handle, requiring the driver to stay alert.
- Do not use the ACC function when driving on congested roads, rugged or steep roads, wet and slippery surfaces like rain, snow, ice, off-road areas, or road sections without a surface, to avoid loss of vehicle control and accidents.
- The set cruising speed and distance from the vehicle ahead must be adapted to the current traffic conditions and external environment. The Adaptive Cruise Control system (ACC) is an assistance system and should be used cautiously.

Using the Function

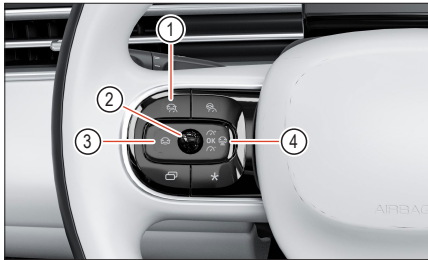

Activating/Deactivating the Function

Press the ACC function button ①. If activation conditions are met, the ACC indicator light  (green) illuminates on the instrument cluster display, indicating “Adaptive Cruise Control Activated.” ACC is then activated and operational.

To deactivate ACC after use, press the cruise control button ① again. The ACC indicator light on the instrument cluster display will turn off, indicating “Adaptive Cruise Control Deactivated.”

Increasing Cruise Speed

When the vehicle is in ACC mode, push and hold the button ② upwards to continuously increase the cruise speed by 1 km/h, and a short push will increase the cruise speed by 5 km/h.

Decreasing Cruise Speed

When the vehicle is in ACC mode, push and hold the button ② downwards to continuously decrease the cruise speed by 1 km/h, and a short push will decrease the cruise speed by 5 km/h.

Adjusting Following Distance

When the vehicle is in ACC mode, briefly press button ③ to decrease the following distance; briefly press button ④ to increase the following distance. Adjust the proximity of the following distance (the following distance is positively correlated with the vehicle speed; the faster the speed, the greater the actual following distance at the same setting).

Exiting ACC Mode

Pressing the brake pedal under any condition will exit ACC mode and return control to the driver.

Stop-and-Go Traffic

In ACC mode, the vehicle's speed varies with the speed of the vehicle ahead, ranging from 0 km/h to the set speed, maintaining the set time distance and following until stopping:

- If the leading vehicle moves within 3s of stopping, your vehicle will automatically start following.
- If stopped for more than 3s, the driver must flick the cruise control button ② upwards or lightly press the accelerator to reactivate ACC, allowing the vehicle to automatically start from a stop and accelerate to follow.
- If stopped for more than 5 minutes, ACC will deactivate, and the EPB (Electronic Parking Brake) will be activated.

Driving Assistance

Indicator Lights

When ACC is activated, the indicator light  illuminates in green. If not activated, it remains off.

If ACC malfunctions, the indicator light  illuminates in red, indicating the need to check if the camera is obstructed.

In emergency situations ahead, the system will prompt "Please Take Over" or "Please Take Over Immediately," accompanied by a buzzer alarm.

If the driver presses the accelerator pedal during ACC activation, the vehicle enters override mode (driver takeover), and the set cruise speed will flash.

Function Limitations

The Adaptive Cruise Control (ACC) camera sensor has a limited detection range. In the following situations (including but not limited to), the sensor may fail to detect the vehicle ahead or misdetect, leading to delayed system response or unintended braking due to collision risk:

- When approaching or driving through a curve, the ACC system may misidentify vehicles in other lanes or fail to recognize vehicles in the same lane.
- If the vehicle ahead is positioned diagonally in front and potentially outside the detection range, the ACC system may not recognize it.
- If a vehicle moves into the same lane in front, posing a collision risk, the ACC system may unexpectedly brake.
- If the vehicle ahead is turning and there is a stationary vehicle further ahead, there is a collision risk and the ACC system may unexpectedly brake.
- While driving on sloped roads, the ACC system may fail to detect vehicles ahead.

In addition to the above situations, drivers using the ACC system should be vigilant and ready to take over control when encountering the following conditions, and turn off the ACC system if necessary:

- Rapidly approaching the vehicle ahead or if the vehicle ahead suddenly brakes, and the ACC system cannot apply sufficient braking force.
- Encountering trucks or trailers with higher chassis.
- The camera sensor's performance may be affected while driving in tunnels, possibly failing to detect distant vehicles or having unstable detection.
- Adverse weather conditions like heavy fog, rain, snow, or sandstorms can affect sensor detection performance.
- Low road friction coefficient, where rapid changes in tire traction can cause the vehicle to slip.
- Insufficient or excessive ambient lighting around the vehicle can affect sensor detection performance.
- The presence of objects like rails or metal plates on the road ahead can interfere with sensor detection.
- Vehicle collisions, severe vibrations, or other incidents that might change the sensor's position.
- If the vehicle ahead has items protruding from its sides or rear end, the ACC system may not recognize these items.

3

When Driving

Intelligent Cruise Assist (ICA)*

Intelligent Cruise Assist (abbreviated as ICA), including Traffic Jam Assist (TJA) and Highway Assist (HWA), is an advanced driving assistance system that integrates longitudinal and lateral control of the vehicle. It encompasses all functionalities of Adaptive Cruise Control (ACC) and further assists in centered driving. It can be quickly activated via the steering wheel buttons.

Intelligent Cruise Assist

The Intelligent Cruise Assist system automatically steers and follows the vehicle ahead, significantly reducing the driver's driving intensity, making driving more relaxed and safer.

The Intelligent Cruise Assist system can control the vehicle longitudinally and laterally within a speed range of 0 to 140 km/h. When lane markings on both sides are clear, it can operate in cruise mode (when no target vehicle is detected) and following mode (when a target vehicle is detected), without the driver needing to control the accelerator pedal, steering wheel, or brake pedal. In addition, it keeps the vehicle centered between the lane lines when lane markings are clear on both sides.

Traffic Jam Assist

Traffic Jam Assist system offers integrated longitudinal and lateral control of the vehicle within the 0 to 60 km/h speed range. When lane markings on both sides are clear, it can automatically keep the vehicle centered in its lane. When only one side lane marking is clear or when both are unclear but there is a target vehicle ahead, the vehicle can automatically follow the trajectory of the car in front within a certain range.

Highway Assist

Highway Assist system provides integrated longitudinal and lateral control of the vehicle within the 60 to 140 km/h speed range. When lane markings on both sides are clear, it can automatically keep the vehicle centered in its lane.

Overtake Mode

If the driver presses the accelerator pedal while ICA is active, the system will enter the overtake mode (driver takeover), and the cruise speed will flash.

CAUTION

- The ICA system is an assistant to the driver, intended to enhance comfort and safety, but it cannot replace the driver. Even when ICA is active, the driver must drive cautiously, always maintain control of the vehicle, and follow traffic rules.
- In certain situations (e.g., when the safety distance to the vehicle ahead is too small, or relative speed is too high, or the vehicle ahead suddenly changes lanes), the system may not have enough time to reduce the vehicle's speed. In such cases, the driver must react promptly.
- When entering and exiting curves, target selection may be delayed or interfered with. The ICA system may not work as expected or may act too late in these situations.
- The ICA system is suitable for use on highways and well-conditioned roads but not for complex urban roads or mountain roads.
- If the distance between the vehicle and the vehicle in the adjacent lane is too small (or a vehicle in the adjacent lane is too close to your lane), the system may react to the adjacent vehicle and brake.
- When affected by environmental factors (e.g., heavy rain) or due to the target's characteristics, the camera sensor's monitoring may be interfered with, decreasing performance.

- If a vehicle changes lanes into your path within ICA's detection range and is recognized as a target vehicle, the system may react to it, possibly causing strong braking or delayed braking. The driver should take over promptly to avoid accidents.
- When the vehicle's overlap with the vehicle ahead is too small, ICA may not recognize the vehicle ahead as a target. In this case, the driver must maintain control of the vehicle.
- Do not change the position of the camera sensor.
- The ICA system works only for stationary or forward-moving vehicles and does not act on oncoming or crossing vehicles.
- In rare cases during the process of stopping behind a leading vehicle, the system may not recognize the vehicle's rear end but instead recognize the lower end of the target (e.g., the rear axle of a high-chassis truck or the vehicle's bumper). The system cannot guarantee an appropriate stopping distance, and the driver must remain alert and ready to brake.
- Due to physical limitations, the ICA system cannot guarantee safe and reliable operation in all conditions. If you have any questions about the function, please contact an authorized dealership.

- Sensors that are dirty or covered can limit functionality. Do not cover the sensor detection area; if necessary, clean the sensors carefully. Keep the windshield glass clean.
- In more complex lane sections (intersections, sudden changes in lane markings, lane convergence, etc.), there may be situations where lane information is temporarily undetectable. Always maintain control of the vehicle.
- Intelligent Cruise Assist keeps the vehicle centered in the lane. In special cases, turn off or use the turn signal to suppress this function (e.g., when overtaking a truck).

WARNING

- Do not use the ICA system while driving on congested roads, in windy areas, on rugged or steep roads, or on wet and slippery surfaces like rain, snow, and ice, to prevent loss of vehicle control and accidents.
- Do not use the ICA system when driving in off-road areas or on sections without paved surfaces. This feature is only intended for use on hard-surfaced, paved roads; using it otherwise could result in an accident.

Intelligent Cruise Assist (ICA) Activation Conditions

- READY light is illuminated.
- Electronic Parking Brake (EPB) is released.
- Vehicle gear is in D.
- No rollback in the vehicle.
- Failure to turn on turn signals;
- Failure to turn on the Hazard Warning light;
- All doors, hood, and tailgate are closed.
- Driver's side seat belt is fastened.
- ESC off indicator light on the instrument cluster is not illuminated.
- Vehicle speed is below 130 km/h.
- When the vehicle is not stationary, the brake pedal is not pressed.
- ICA malfunction warning light is not illuminated.
- ESC, EMS, EPS can respond normally to ADAS commands.
- Vehicle is on a slight incline.
- The driver is holding the steering wheel without making large, fast, or strong movements.
- No other ICA or ACC system inhibiting conditions are present.

ICA Hands-off Warning Reminder

When the ICA function is active, if the driver's hands leave the steering wheel for more than 15s, a first-level warning reminder is issued (instrument panel warning flashes). If the hands-off condition persists for more than 10s after the first-level warning, a second-level warning is issued (instrument panel warning flashes with an auditory alarm). If the hands-off condition continues for more than 20 seconds after the second-level warning, the ICA system will exit and stop issuing reminders.

⚠ WARNING

Drivers should promptly take control of the steering wheel after the ICA system issues a warning reminder to avoid serious accidents.

Activating or Deactivating the Function

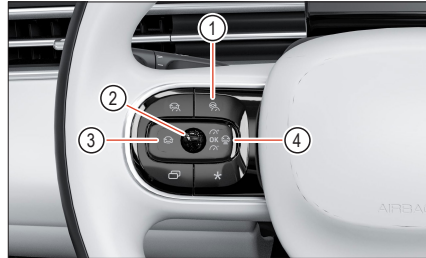

Press the ICA function button ① to activate the ICA system. If all activation conditions are met, the ICA indicator light  (green) will illuminate on the instrument cluster display, with the message "Intelligent Cruise Assist system activated," indicating that the ICA system is activated and operational. To deactivate the ICA system, press button ① (turn off ICA); the ICA indicator light on the combination instrument will go out, and the message "Intelligent Cruise Assist system deactivated" will appear.

If the ICA system encounters factors causing functional degradation, it will downgrade, showing gray lane lines on the instrument cluster and illuminating the ICA indicator light  (orange).

If the degrading factors are eliminated within 30 seconds, the ICA system can automatically reactivate, illuminating the ICA indicator light  (green).

If the ICA is deactivated due to unmet activation conditions, the ICA function will automatically exit, and the ICA indicator light  (green) will turn off.

The ICA can be reactivated if all activation conditions are met by pressing button ①, setting the speed to the speed at the time of pressing the button.

Increasing Cruise Speed

When the vehicle is in ICA mode, push and hold the button ② upwards to continuously increase the cruise speed by 1 km/h, and a short push will increase the cruise speed by 5 km/h.

Decreasing Cruise Speed

When the vehicle is in ICA mode, push and hold the button ② downwards to continuously decrease the cruise speed by 1 km/h, and a short push will decrease the cruise speed by 5 km/h.

Setting Vehicle Interval Distance

When the vehicle is in ICA mode, briefly press button ③ to decrease the following distance; briefly press button ④ to increase the following distance. Adjust the proximity of the following distance (the following distance is positively correlated with the vehicle speed; the faster the speed, the greater the actual following distance at the same setting).

Driving Assistance

Factors Affecting Function Degradation

Due to unavoidable environmental factors and vehicle states, the Intelligent Cruise Assist (ICA) may operate in a degraded mode, where it only functions as ACC without lane centering assistance. Examples of ICA system downgrade reasons include:

Vehicle Environment Impact:

- Vehicle environment in dual lane line following mode:
 - Too small road turning radius;
 - Lane is too wide or too narrow;
 - Lane lines are unclear or unrecognizable;
- Single lane line or no lane line following mode:
 - Vehicle speed exceeds 60 km/h;
 - Distance between the front vehicle and your vehicle exceeds 150 m.

Overall Vehicle State:

- Hazard lights are on or turn signal lever is fully engaged.
- Steering wheel absolute angle is too large.
- Steering wheel is turning too quickly.
- Large lateral or longitudinal acceleration in the vehicle.
- Large longitudinal deceleration in the vehicle.
- Excessive torque applied by the driver on the steering wheel.

Function Malfunction

If ICA malfunctions, the ICA malfunction warning light  (red) on the instrument cluster will illuminate with a message "Intelligent Cruise Assist System Failure," and you should check if the camera is obstructed.

If the warning light remains illuminated after restarting, contact an authorized dealership for repair as soon as possible.

Limitations of the Intelligent Cruise Assist (ICA) Function

The ICA's camera sensor has a limited detection range. In some cases, sensors may not detect the vehicle ahead or may delay in detecting the vehicle ahead.

The following sensor detection issues may cause delayed system response or unexpected braking:

- When approaching or driving through a curve, the ICA system may misidentify vehicles in other lanes or fail to recognize vehicles in the same lane.
- When there is minimal overlap between the vehicle ahead and your vehicle, it may be outside the system's detection range, and the ICA system may not be able to recognize that vehicle.
- When a vehicle is changing lanes into your vehicle's path.
- When the vehicle ahead is turning and there is a stationary vehicle further ahead.
- While driving on sloped roads, the ICA system may fail to detect vehicles in the same lane.

In addition to the above situations, drivers using the ICA system should be vigilant and ready to take action or brake when encountering the following conditions, and turn off the ICA system if necessary:

- Rapidly approaching the vehicle ahead or if the vehicle ahead suddenly brakes, and the ICA system cannot apply sufficient braking force.
- Encountering trucks or trailers with higher chassis.
- The camera sensor's performance may be affected while driving in tunnels, possibly failing to detect distant vehicles or having unstable detection.
- Adverse weather conditions like heavy fog, rain, snow, or sandstorms can affect sensor detection performance.
- Low road friction coefficient, where rapid changes in tire traction can cause the vehicle to slip.
- Poor ambient lighting conditions around the vehicle can affect sensor detection performance.
- The presence of objects like rails or metal plates on the road ahead can interfere with sensor detection.
- Vehicle collisions, severe vibrations, or other incidents that might change the sensor's position.
- If the vehicle ahead has items protruding from its sides or rear end, the ICA system may not recognize these items.
- Driving at high speeds in lanes with a small radius of curvature.

Traffic Sign Recognition (TSR)*

The Traffic Sign Recognition System utilizes a camera located at the top of the front windshield to identify different traffic signs on the road. It can detect traffic signs within a range of 140 meters ahead of the vehicle, above, or on the side of the road.

As the vehicle passes a traffic sign, the sign is displayed as an image on the instrument cluster and automatically disappears after a certain distance. "No Entry" and "Stop and Yield" signs start displaying as soon as they are recognized by the camera and disappear after a certain distance.

The Traffic Sign Recognition System is an auxiliary system and is not a substitute for human judgment. Even when the system is activated, the driver must drive cautiously, always maintain control of the vehicle, and adhere to traffic rules.

If the traffic signs recognized by the system differ from the actual road signs, please refer to the actual road signs.

Driving Assistance

Recognizable Signs

Recognizable signs include Construction, Crossroads, Slippery Road, Falling Rocks, Danger, Pedestrians, Children, No Overtaking, End of No Overtaking, No Right Turn, No U-Turn, No Left Turn, Stop and Give Way, No Entry for Motor Vehicles, and other No Entry signs.

Function Settings

The Traffic Sign Recognition function can be turned on or off in the MP5 Assisted Driving → Smart Recognition interface.

Factors Affecting the Function

Due to unavoidable environmental factors and conditions, the Traffic Sign Recognition function may incorrectly identify or fail to recognize traffic signs. In the following situations, the functionality may be affected or not work:

- Poor visibility, such as snow, rain, or fog.
 - Obstructions in front of the camera.
 - High temperatures around the camera due to direct sunlight.
 - Glare caused by direct sunlight, oncoming traffic, reflections from wet roads, etc.
 - Sudden changes in outdoor brightness, such as when entering/exiting tunnels.
 - Low light conditions at night or inside tunnels without the front headlights on.
 - Signs in complex areas, far from the vehicle, in spots not illuminated by headlights, or at road corners.
 - Signs that are faded, bent, rotated at an angle, damaged, covered with mud or snow, obscured by trees, or blocked by other objects or vehicles.
 - Signs partially obscured by trees or other objects.
 - Reflections of lights or shadows on the sign surface.
 - Signs that are too bright or too dark (electronic signs).
 - Small traffic signs, such as those in combination signboards.
- Difficulty recognizing the graphics on the sign.
 - Potential misidentification of signs not in the lane, especially when signs are placed near the lane (e.g., at junctions between side roads and main roads).
 - Misidentification of objects similar in color or shape to signs (similar signs, electronic signs, billboards, buildings, etc.).
 - Inability to recognize auxiliary signs that provide additional information like weather, time, vehicle type, etc.

Intelligent Speed Assist (ISA)*

The Intelligent Speed Assist function (ISA) uses a camera located at the top of the front windshield to recognize road speed limit signs. When the vehicle passes a speed limit sign, the intelligent speed limit reminder function will display the detected speed limit sign at a designated position on the combination instrument. The speed limit sign display will disappear after a certain distance. If the vehicle's speed exceeds the current road speed limit plus the set speed deviation value, the instrument cluster alerts the driver with sound/icon flashing for overspeeding.

 **CAUTION**

Intelligent Speed Assist is an auxiliary system and is not a substitute for human judgment.

Function Settings

The Intelligent Speed Assist function can be turned on or off in the MP5 Assisted Driving → Smart Recognition interface. The reminder setting only activates the ISA function.

Speed deviation can also be set (0 km/h, +5 km/h, or +10 km/h).

Function Status Explanation

When the speed limit reminder system is set to on and the system is fault-free, the ISA system icon in the MP5 display lights up. If the system malfunctions, the instrument cluster displays "Intelligent Speed Limit Fault," requiring a check for camera obstruction or connector issues. If the fault persists, contact an authorized dealership for repair.

Speed Limit Reminder

The Intelligent Speed Assist function recognizes speed limit signs in two ways and provides reminders:

- Camera-recognized speed limit reminder: The vehicle's camera starts displaying the speed limit when approaching a speed limit sign and stops displaying after a certain distance.

If a speed limit cancellation sign is recognized during the camera-obtained speed limit reminder process, the function will end the speed limit reminder in advance.

Driving Assistance

Overspeed Alarm

If the vehicle's speed exceeds the current road speed limit plus the set speed deviation value, an overspeed alarm is issued. The alarm format includes flashing speed limit sign icons and a buzzer alert to prevent unconscious overspeeding. The flashing stops when the vehicle speed on the instrument cluster falls below the limit or after continuous overspeeding for a certain time.

Factors Affecting the Function

Refer to the "Factors Affecting the Function" section under "Traffic Sign Recognition System (TSR)"* for factors that may affect the Intelligent Speed Assist functionality.

Intelligent Speed Limit Control (ISLC)*

The Intelligent Speed Limit Control function (ISLC) uses a camera located at the top of the front windshield to recognize road speed limit signs. When the vehicle passes a speed limit sign, the intelligent speed limit reminder function will display the detected speed limit sign at a designated position on the combination instrument. The speed limit sign display will disappear after a certain distance. If the recognized speed limit differs from the set cruise speed on the instrument cluster by more than the set speed deviation value, ISLC prompts the driver to confirm whether to update the ACC cruise speed for speed control.

Activation Conditions of the Function

The Intelligent Speed Limit Control system can be used under the following conditions:

- The function is turned on and the mode is selected.
- Vehicle speed between 30~140km/h.
- There are no system faults.
- ACC is activated.

Function Settings

The Intelligent Speed Limit Control function can be turned on or off in the MP5 Assisted Driving → Smart Recognition interface. Touching the control activates both ISA and ISLC functions.

Speed deviation can also be set (0 km/h, +5 km/h, or +10 km/h).

Function Status Explanation

When the Intelligent Speed Limit Control system is set to on and the system is fault-free, the ISLC function button in the MP5 display lights up. If the system malfunctions, the instrument cluster displays "Intelligent Speed Limit Fault."

Speed Limit Reminder

The vehicle's camera starts displaying the speed limit when approaching a speed limit sign and stops displaying after a certain distance.

If a vehicle changes lanes or the camera recognizes a speed limit cancellation sign during the camera-obtained speed limit reminder process, the function will end the speed limit reminder in advance.

Overspeed Alarm

When the vehicle's speed displayed on the instrument cluster exceeds the set speed deviation value, an overspeed alarm is triggered. The alarm consists of the speed limit sign icon flashing and a buzzer alarm. The flashing stops when the vehicle speed on the instrument cluster falls below the limit or after continuous overspeeding for a certain time.

Cruise Speed Control

The Intelligent Speed Limit Control function uses the camera to obtain speed limit information. When the effective speed limit obtained and the current cruise speed set on the instrument cluster differ by more than -10 km/h, -5 km/h, or -10 km/h (set in the MP5 display), ISLC prompts the driver with an operation pop-up reminder at the designated location on the instrument cluster. This pop-up reminder flashes briefly and then remains static for a short time. If the driver confirms within the prompted time range, the pop-up reminder ends, and the set cruise speed is updated to the effective speed limit, with ISLC controlling the vehicle speed. If the driver does not confirm within the prompted time, the pop-up reminder ends after the vehicle travels a certain distance.

Factors Affecting the Function

Refer to the "Factors Affecting the Function" section under "Traffic Sign Recognition System (TSR)*" for factors that may affect the Intelligent Speed Assist functionality.

Parking Assistance

WARNING

Under no circumstances does parking assistance replace or absolve the driver's responsibility.

CAUTION

- If one or more sensors are damaged or have a bad connection, the buzzer sounds for 3s as a warning, and the reverse parking radar system is inoperative, requiring extra caution when reversing.
- Reverse at a slow speed, preferably less than 5km/h.

Situations When the Rear Reverse Parking Radar Does Not Work

1. Sensors are iced or damp (they work normally after defrosting or drying).
2. Sensors are covered or blocked by external elements like heavy rain, snow, or water (they work normally after removing the obstructions).
3. Driving on rugged terrain (unpaved roads, gravel, bumpy roads, or steep slopes).
4. Large noise interference within the sensor detection range (e.g., vehicle horns or truck air brakes).
5. Radio transmitters within the sensor detection range.

3

Reverse Parking Radar

This vehicle is equipped with a reverse parking radar system. When reversing or parking in tight spots, multiple sensors on the rear bumper detect obstacles behind the vehicle and their proximity, assisting the driver with safe, easy reversing and parking to avoid collisions.

System Self-Check Feature

In reverse gear, the parking radar system automatically checks if all sensors are functioning properly. A single beep of the buzzer indicates that the radar system is in normal detection working state.

Rear Reverse Parking Radar Alert

The buzzer sounds in different frequencies based on the distance of the obstacle detected by the reverse parking radar sensors.

When the sensor detects an obstacle within the detection zone, the buzzer will emit an alarm sound at varying frequencies based on the distance to the obstacle.

Rear Reverse Parking Radar Activation Conditions

After the READY light is illuminated, place the electronic shift lever in "R" (Reverse) to activate the rear parking aid; moving the electronic shift lever out of "R" will deactivate the rear parking aid.

When Driving

Obstacles the Radar May Fail to Detect

The radar might fail to detect obstacles in the following positions:

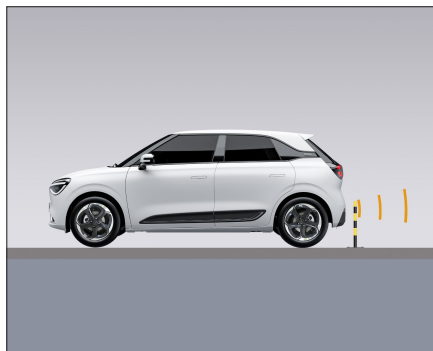

1. Thin or slender objects like steel cables, chains, thin poles, and stakes might not be detected.

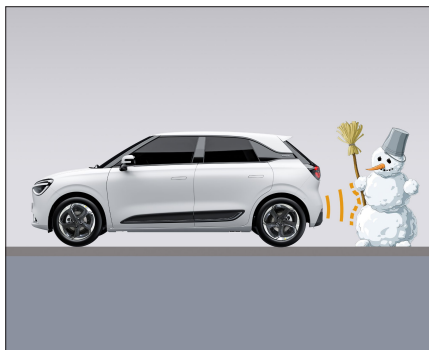

2. Objects that can absorb the sensor's frequency like snow, clothing, or sponge materials might not be detected.

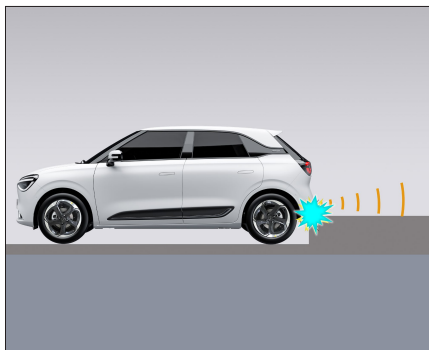

3. Obstacles below the detection range, such as small animals, low steps, or lower objects, might not be detected.



4. Obstacles above the detection range, like hanging items, partially open rolling shutters, or the rear of trucks, might not be detected.

Parking Assistance

Reverse Camera*

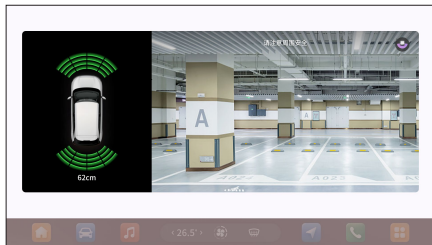

When the gear is shifted to the "R" (reverse) position, the MP5 display screen automatically switches to show the view behind the vehicle.

This system helps the driver observe the scene behind the vehicle via the display screen, helping to avoid damaging the vehicle. However, there are blind spots in the camera's field of view, such as small objects under the bumper or objects close to the rear and side corners of the bumper.

Reverse Camera Position

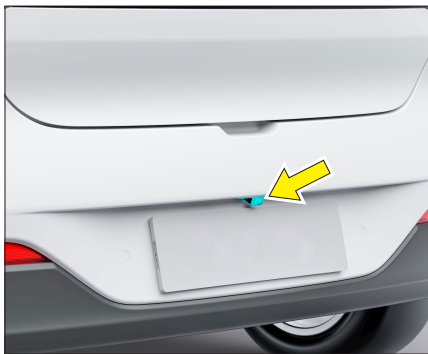

The reverse camera is located in the middle of the rear bumper, above the license plate.

Situations When the Camera May Not Work Properly

- Driving in stormy weather or fog;
- When the camera's surface is iced over or covered in mud, dust, or snowflakes;
- Reversing at night without rear lights.

WARNING

- Due to individual visual differences, vehicle movement, and the shape of obstacles, the distance estimated on the display screen may differ from the actual distance.
- Keep the camera clean and ensure it is not covered in mud, frost, or snow.

Reverse Camera Operation Tips

The system requires some time to initialize when activated. If the display is not clear due to very high or low temperatures or very bright or dark lighting conditions, it is not a malfunction. Shadows of objects might appear on the display screen. This is due to sunlight reflecting off the bumper and is not a malfunction.

Under fluorescent lights, the images displayed on the screen might flicker. This is not a malfunction.

The color of objects on the display screen might differ from their actual color.

If the rear-view camera is covered with dirt, rain, or snow, the objects displayed may not be clear. Clean the rear-view camera in such cases.

Parking Assistance

CAUTION

- When in reverse gear, if the speed exceeds 30km/h, the system will automatically shut off, reverting to the previous rear view when the speed drops below 27km/h.
- If activated by reverse gear or turning signal and the speed exceeds 30km/h, the system will automatically shut off, reverting to the MP5 screen; it resumes the panoramic view when the speed drops below 27km/h.

Deactivation

- If not in reverse gear, tap the "Exit" icon on the panoramic view screen to turn off the system;
- If activated by the turning signal, turn off the signal to deactivate the system;
- If activated by shifting into reverse gear, shifting out of reverse and into park will deactivate the system.
- If activated by reverse gear or turning signal and the speed exceeds 30km/h, the system automatically deactivates (resuming panoramic view when speed drops below 27km/h).

2D Surround View Angle Switching



When the surround view system is displaying images, the following operations can be performed to switch the surround view angles:

- In the panoramic view, by clicking on the vehicle graphic's front (rear, left, or right) viewing area, the display will switch to show the front (rear, left, or right) view.

2D/3D View Switching



In the surround view imaging state, touching the "2D View" / "3D View" icon allows switching between panoramic view + 2D single view and panoramic view + 3D view modes.

Surround View System Settings

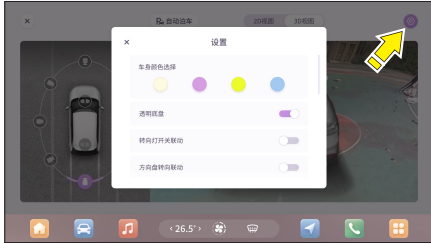

- Enter the surround view interface, touch the “Settings” icon to pop up more settings for the surround view, including options for vehicle body color selection, transparent chassis, turn signal linkage, steering wheel turning linkage, radar-activated imaging, radar shield display, obstacle distance display, and auxiliary line display.
- When turn signal linkage / steering wheel turning linkage is enabled, the surround view system automatically displays panoramic imaging when the left/right turn signal is activated or the steering wheel is turned.
- The transparent chassis feature, when enabled, allows viewing the vehicle's surroundings through the vehicle body when the system is in 3D view.

Parking Assist Lines

When the assist line display is enabled in the panoramic view + 2D single view mode, dynamic assist lines are overlaid in the front and rear single-view screens:

- Red line segment: Approximately 0~0.35m from the vehicle's front/rear bumper, indicating a warning area where the driver should immediately stop.
- Yellow line segment: Approximately 0.35~0.9m from the vehicle's front/rear bumper, indicating a buffer area, reminding the driver to control the speed.
- Green line segment: Approximately 0.9~3m from the vehicle's front/rear bumper, indicating a safe area.
- The width of the lines on both sides is approximately 0.2m from each side of the vehicle.

In panoramic view + 2D single view mode, when the steering wheel is turned, the dynamic assist lines (as shown in the panoramic view + rear view) change according to the steering wheel angle, predicting the general trajectory of the vehicle's movement.

CAUTION

- The width between the two driving trajectory assist lines may be wider than the actual width of the vehicle.
- Depending on the vehicle's load condition (number of passengers, luggage weight, etc.), the position of the assist lines shown on the screen may change. Always check the vehicle's surroundings when driving.
- Due to individual visual differences, vehicle movement, and the shape of obstacles, the distance estimated on the display screen may differ from the actual distance.
- When reversing uphill from a flat surface, the actual distance to obstacles may be closer than what appears on the screen. Be particularly cautious not to collide with objects on the reversing path.
- Due to blind spots in the camera's field of view, images near the front bumper, rear bumper, and the vehicle's corners cannot be displayed in the surround view.

Parking Assistance

Operating Tips for Surround View System

When the vehicle is powered on, the system starts and initializes. During the initialization process, the displayed images might be unstable.

If the display is not clear due to very high or low temperatures or very bright or dark lighting conditions, it is not a malfunction.

Shadows of objects might appear on the display screen. This is due to sunlight reflecting off the bumper and is not a malfunction.

Under fluorescent lights, the images displayed on the screen might flicker. This is not a malfunction.

The color of objects on the display screen might differ from their actual color.

If rainwater, dirt, snow, or other foreign objects adhere to the camera lens, the image displayed might be unclear. It's essential to clean the camera lens in such cases.

Fusion Automatic Parking System*

Fusion Automatic Parking Assist Feature

The Fusion Automatic Parking Assist System (FAPA) relies on ultrasonic radar sensors and surround-view cameras. It uses ultrasonic and visual fusion to detect parking spaces and obstacles around the vehicle. Once a parking space is identified, the parking controller automatically plans the parking path, controlling the braking, acceleration, steering, and gear mechanisms to achieve automatic parking in or out of the space.

During the automatic parking process, drivers should pay attention to the environment around the vehicle and take over the vehicle if necessary.

The Fusion Automatic Parking Assist System supports functions such as searching for parking spaces, horizontal parking in, vertical parking in, diagonal parking in, and horizontal parking out.

The Fusion Automatic Parking Assist feature is only active when the vehicle is in READY state.

To use the system, enter the surround-view interface on the MP5, press the automatic parking assist button, and follow the graphical and textual prompts on the display screen to complete the automatic parking.

CAUTION

In the following conditions, do not use the Fusion Automatic Parking feature to avoid unavoidable risks during use:

- In poor weather conditions, such as slippery, muddy roads with puddles, ice, or snow;
- On surfaces with significant slopes or height differences, such as near cliffs, ponds, or raised roadside edges.

WARNING

- Fusion Automatic Parking is only an assistive feature and cannot replace the driver's observation and judgment! When the system is working, drivers still need to confirm the surroundings of the vehicle and strictly follow the system's prompts to avoid accidents.
- The Fusion Automatic Parking Assist System may not detect certain special obstacles, so drivers must confirm whether parking is appropriate and safe.

⚠ WARNING

- For parking spaces not formed by two vehicles, such as between two trees, between a vehicle and a tree, or between a vehicle and other obstacles, drivers must confirm whether it is suitable for parking.
- During horizontal parking out, the radar is in a static detection mode and cannot fully identify the surrounding environment; the driver must judge the direction of parking out to avoid hitting curbs or crossing ditches.
- The parking space search feature cannot identify no-parking zones and special parking space markings; drivers must confirm compliance with traffic laws and regulations.
- If the curb material is not stone or undetectable, and the parking space depth is shallow, improper parking might damage the vehicle's tires or rims.
- During the automatic parking process, sensors for curbs, wheel stops, and other low obstacles may not work properly, posing a collision risk. Drivers should always observe their surroundings and intervene manually when necessary.
- Please carefully read and comply with the relevant information and warning instructions.

Conditions for Activating the Automatic Parking Feature Parking In Operation

- Vehicle in READY state;
- Ultrasonic sensors functioning properly;
- Surround-view cameras functioning properly;
- Steering system functioning properly;
- Vehicle stationary;
- All doors closed;
- Driver's side seat belt is fastened.



A reminder popup appears if parking conditions are not met.

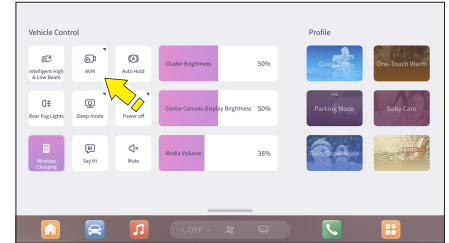

1. Turn on the READY light, enter the surround-view interface from the quick menu bar, press the automatic parking assist button, shift to D gear, and start the automatic parking feature. The vehicle automatically enters the parking space search interface.

Parking Assistance



2. Keep the vehicle speed within 15 km/h, the vehicle 0.5m~2.0m from the reference object in the parking space, and maintain a straight line, the system starts searching for a parking space, after the system finds a parking space, the driver steps on the brake pedal, and the audio touch display screen shows "Please keep the vehicle stationary, select a parking space" and displays the currently searched alternative parking spaces;
3. Touch the parking space icon on the touchscreen to select the desired parking space.
4. After selecting the parking space, the multimedia screen enters the parking method selection interface, choose "Start Parking".



5. After selecting a parking spot, the MP5 display will show "Please release the brake pedal and remove your hands from the steering wheel." Once the driver confirms that the surrounding environment is safe, they should release the brake pedal and remove their hands from the steering wheel, and the system will begin to automatically park the vehicle into the space.



6. Until the MP5 screen displays "Parking completed, please take over the vehicle," the vehicle completes parking.

NOTE

- Upon activating the parking assist feature, if the vehicle is not in 'P' (Park) gear, the system will default to parking mode and begin searching for a parking spot; if the vehicle is in 'P' gear, the system will default to exiting parking mode.
- When only one parking space is available, the system automatically selects that space.

CAUTION

In the following situations, the system may not accurately detect parking spaces:

- Vertical or parallel parking spaces formed by pillars (or other non-vehicular reference objects) on both sides may not be detected;
- Vertical or parallel parking spaces formed by a pillar (or other non-vehicular reference objects) on one side and a vehicle on the other may not be detected;
- Step-like lawns or flower beds may be recognized as parking spaces;
- Severely damaged parking lines may not be recognized;

CAUTION

- Parking lines obscured by shadows may not be recognized;
- There may be small obstacles in the parking space that cannot be recognized;
- Roads with sharp, small obstacles may not be recognized;
- Horizontal line parking spaces with a line in the middle may be recognized as vertical parking spaces;
- Damaged or shadowed lines between adjacent vertical line parking spaces may be recognized as horizontal parking spaces;
- Diagonal line parking spaces with an angle not at 60° may not be recognized;
- Uneven surfaces (including multi-level garages) may not be recognized.

Parking Out Function Operation

1. Turn on the READY light and press the automatic parking assist button in the surround-view interface to start the automatic parking function.



2. After the driver confirms the direction of parking out, touch the "Left Parking Out" or "Right Parking Out" icon on the MP5 to activate the automatic parking exit function.

NOTE

When parking out, if the gear is in "P", the brake pedal needs to be pressed when selecting "Left Parking Out" and "Right Parking Out".

- If there is sufficient space in front of the vehicle, the MP5 shows a prompt "Front space is sufficient, please park out yourself, parking system exiting":



- If there is insufficient space in front and behind the vehicle, the MP5 shows a prompt "Insufficient front and rear space, parking system exiting":



Parking Assistance

- Upon activation of the Park Out Assist feature, the MP5 display reads "Please release the brake pedal." After the driver confirms the surrounding area is safe and releases the brake pedal, the system initiates the automatic parking exit maneuver.
- Once the parking exit is complete, the multimedia touch screen displays "Parking exit complete, please take control of the vehicle." After the vehicle has finished exiting the parking space, the driver should promptly take over control of the vehicle.



Automatic Parking Function Fault Reminder



If a fault occurs in the automatic parking function, the following situations may arise:

- MP5 shows "Parking System Failure", In this case, take over the vehicle and visit a dealership for inspection as soon as possible.

CAUTION

- The system may be affected by weather conditions like rain, snow, and hail. Especially when driving on wet surfaces, ultrasonic sensors may mistake water vapor as a vehicle, affecting the automatic parking function.
- In areas with external noise, other radar sources, strong radar emissions, or strong electromagnetic fields, radar performance may be reduced or even fail.
- During the parking process, the vehicle might occupy the lane of oncoming traffic. Pay attention to surrounding traffic.
- The system has blind spots where it cannot detect people and objects, posing a collision risk. Drivers should always observe their surroundings and intervene manually when necessary.
- For areas that are completely open without obstructions and without parking lines, the automatic parking assist system cannot find parking spaces.
- Ensure rearview mirrors are unfolded when using the system.

 CAUTION

- To ensure vehicle safety and avoid scraping against low obstacles like curbs, the final position of the vehicle after horizontal parking might be slightly outward.
- When washing the car, do not spray the ultrasonic sensors directly with a high-pressure water gun to avoid damaging them.
- Regularly check tire pressure to ensure it meets the required standards. Do not use the system if anti-skid chains are installed or if a spare wheel is used.
- Do not let the ultrasonic radar sensors be covered; any abnormal signal from a sensor will affect the automatic parking system.

4. Vehicle Equipment

Heating and Air Conditioning	160	Sun Visors	166
Air Conditioning Vents	160	Sun Visors	166
Air Conditioning System Adjustment	161	Large Vanity Mirror	166
Air Conditioning Refrigerant	163	Storage Devices	167
Air Conditioning Filter	163	Front Center Console Storage Box	167
Electrical Equipment Interfaces	164	Trunk	167
12V Power Socket and USB Interface	164	Horn Switch	168
Diagnostic Interface	165		
Wireless Phone Charging*	165		

Heating and Air Conditioning

Air Conditioning Vents

Central Air Vents



Moving control knob ① adjusts the air flow direction (up/down, left/right) of the vent to the desired position. Sliding control knob ① inward to the limit position closes the vent.

i NOTE

When the vent is closed, a certain degree of air flow may still occur. Air leakage from the vent is normal.

Side Air Vents

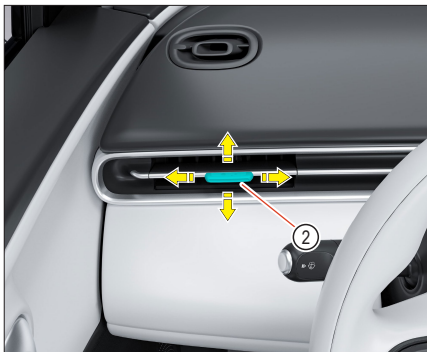

Moving control knob ② adjusts the air flow direction (up/down, left/right) of the vent to the desired position. Sliding control knob ② inward to the limit position closes the vent.

⚠ WARNING

- During driving, to remain fully focused on driving, please do not adjust the heating or air conditioning.
- If foreign objects enter the vent, liquids splash onto it, smoke is observed coming from the vent, or any other abnormal situations occur, immediately stop ventilation and contact the nearest dealership for inspection. Ignoring these abnormalities may lead to accidents or fire.

Air Conditioning System Adjustment

Electric Air Conditioning Control (Type I)*

Air Conditioning Instrument Display



- ① Internal/External Circulation Display
- ② "A/C" Display
- ③ Temperature Gear Display
(Smaller value: cooler; Larger value: warmer; Snowflake: cooling; Sun: heating)
- ④ Fan Speed Display
- ⑤ Airflow Mode Display
- ⑥ Front Windshield Defogging Display

Air Conditioning Switch (Right Side of the Multi-Function Steering Wheel)

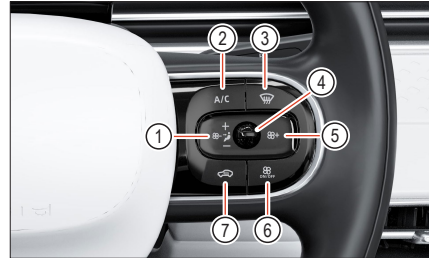

- ① Decrease Air Volume Button
- ② "A/C" Switch - Short press the button to turn on/off the refrigeration compressor.
- ③ Front Windshield Defogging Button
- ④ Airflow Mode Selection Button (Press)/
Temperature + (Flick Up)/ Temperature - (Flick Down)
- ⑤ Increase Air Volume Button
- ⑥ Air Conditioning Switch - Press briefly to turn the air conditioning on/off
- ⑦ Internal and External Circulation Switch Button

Electric Air Conditioning Control (Type II)*

Air Conditioning Display and Switch (Integrated in MP5)



- ① Activate Air Conditioning Panel (Shortcut Bar)
- ② Temperature Control (Shortcut Bar)
- ③ Front Windshield Defogging (Shortcut Bar)
- ④ Temperature Control
- ⑤ Internal/External Circulation Switch
- ⑥ Automatic Internal/External Circulation Switch
- ⑦ Fan Speed Control
- ⑧ Scheduled Travel (Timed Air Conditioning)
- ⑨ Airflow Mode Selection
- ⑩ "A/C" Air Conditioning Button
- ⑪ Air Conditioning Off Button
- ⑫ One-Button Rapid Cooling
- ⑬ Rear Window/Side Mirror Defrosting
- ⑭ Front Windshield Defogging Button

Heating and Air Conditioning

Automatic Air Conditioning Control (Type III)*

Air Conditioning Display and Switch (Integrated in MP5)



- ① Activate Air Conditioning Panel (Shortcut Bar)
- ② Temperature Control (Shortcut Bar)
- ③ Front Windshield Defogging (Shortcut Bar)
- ④ Temperature Control
- ⑤ Internal/External Circulation Switch
- ⑥ Automatic Internal/External Circulation Switch
- ⑦ Fan Speed Control
- ⑧ Scheduled Travel (Timed Air Conditioning)
- ⑨ Airflow Mode Selection
- ⑩ "A/C" Air Conditioning Button
- ⑪ Air Conditioning Off Button
- ⑫ Automatic Air Conditioning Switch
- ⑬ Rear Window/Side Mirror Defrosting
- ⑭ Front Windshield Defogging Button
- ⑮ One-Button Rapid Cooling

Cooling

Illuminate the READY light, adjust the fan speed, then press the "A/C" (cooling) button to activate air conditioning cooling, and adjust to a suitable temperature.

Heating

Illuminate the READY light, adjust the fan speed, then increase the temperature to the red area (position)/near HI for air conditioning heating.

CAUTION

- For maximum heating, set the temperature to the highest setting/HI.
- For maximum cooling, use internal circulation mode and set the temperature to the lowest setting/Lo, with the fan speed at maximum.
- If windows fog up, to defog, activate cooling or heating, turn on the front windshield defogger , and set the fan speed to maximum.

CAUTION

- If hot air is felt from the vents in summer, set the air conditioning to internal circulation mode and lower the temperature.
- Condensation water from the cooling system is discharged through a pre-set pipe. Therefore, a puddle of water may form under the vehicle when it's stopped.
- To maintain good sealing of the compressor, the air conditioning equipment should be operated at least once a month.
- The air conditioning is useful in any season as it removes moisture and steam.
- To achieve good cooling effects, windows must be closed during use.
- If the car is parked in the sun for a long time and the interior temperature rises, open the windows briefly for ventilation, then close them.

Front Windshield Glass Defogging

The front windshield glass defogger  reduces moisture, fog, and frost on the windshield surface to improve the forward view.

When the ambient temperature is high:

- Select the "front windshield" airflow mode;
- External air circulation;
- Increase fan speed;
- Lower the temperature;
- Turn on A/C.

When the ambient temperature is low:

- Select the "front windshield" airflow mode;
- External air circulation;
- Increase fan speed;
- Raise the temperature;
- Turn on A/C.

Rear window/rearview mirror defrosting

The rear window glass defogger/defroster reduces moisture, fog, and frost on the rear window to improve rearward visibility.

Press the rear window/side mirror defrosting button, and the defogger/defroster operates for about 15 minutes. After the preset time, it will automatically shut off.

To turn off the defogger/defroster during operation, press the rear window/side mirror defrosting button again.

 CAUTION
Use external air circulation mode as much as possible to avoid stale air and window fogging inside the car. In dusty weather, choose internal air circulation mode.

Air Conditioning Refrigerant

The refrigerant used in the air conditioning system has been chosen considering its environmental impact. Specialized refrigerant filling machines and lubricants should be used when servicing the air conditioning. Using unqualified refrigerants or lubricants can cause serious damage to the air conditioning system.

 CAUTION
Please visit a dealership for air conditioning system maintenance.

Air Conditioning Filter

The air conditioning system is equipped with a filter to remove dirt, pollen, and dust.

To maintain effective heating, defogging, and ventilation of the air conditioning, clean or replace the air conditioning filter according to the maintenance cycle specified in the vehicle's warranty policy. To replace the air conditioning filter, please contact a dealership.

If the air flow noticeably decreases, or if the windows fog up easily when operating the heating or air conditioning, replace the air conditioning filter.

Electrical Equipment Interfaces

12V Power Socket and USB Interface

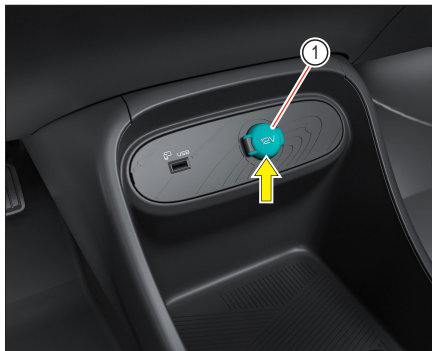

A 12V power socket ① is located at the front of the passenger dashboard.

When the vehicle is powered on, open the power socket cover to use. A car power plug can draw power through the power socket.

After use, restore and cover the power socket plug.

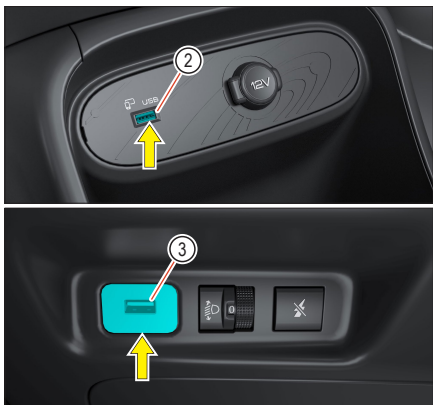

USB interfaces ② are located at the front of the sub-dashboards for charging.

Some models also have USB interfaces ③ on the left side of the dashboard, solely for charging purposes.

⚠ CAUTION

- Avoid prolonged power drawing to prevent draining the 12V battery.
- Strictly follow the usage instructions provided by the manufacturers of the electrical devices.
- Use power-drawing devices compliant with current electromagnetic compatibility standards to avoid interference with the radio and the vehicle's electronic system.

⚠ WARNING

- Do not let children play with the power socket and the electrical devices connected to it to avoid accidents.
- If the connected electrical device overheats, it must be turned off immediately, and the power plug should be unplugged from the socket to prevent fire.
- Do not use electrical devices exceeding the maximum allowed power to avoid vehicle malfunction or fire.
- After use, promptly cover the power socket with its protective cover to prevent foreign objects from falling into it and causing danger.

Diagnostic Interface

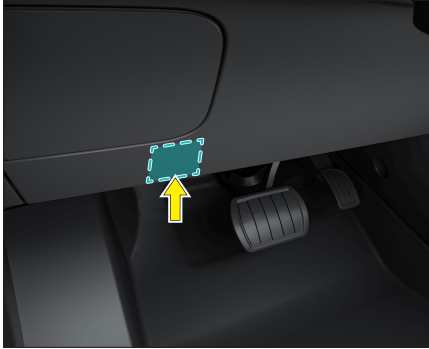

The vehicle is equipped with a Diagnostic Interface (OBD) located at the lower left side of the dashboard. It is used for digital communication between the vehicle's electronic control unit and diagnostic equipment. Connecting devices such as diagnostic tools to this interface can access vehicle electronic control unit data, fault codes, VIN, and other information.

The vehicle VIN can be read using the X431-PRO5 diagnostic tool. The method is: connect to the diagnostic interface, turn on the diagnostic tool, first click on the diagnostic software, select the corresponding vehicle model, then enter the body controller, etc., choose system identification to read the VIN.

Wireless Phone Charging*



The wireless charging sensing area for mobile phones is located at the front part of the dashboard.

Sun Visors

Sun Visors

Blocking Frontal Sunlight

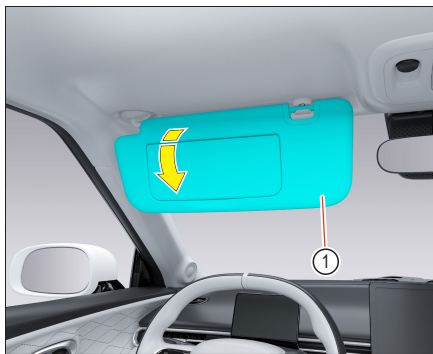

Rotating the sun visor ① downwards can block sunlight coming from the front.

Blocking Side Sunlight

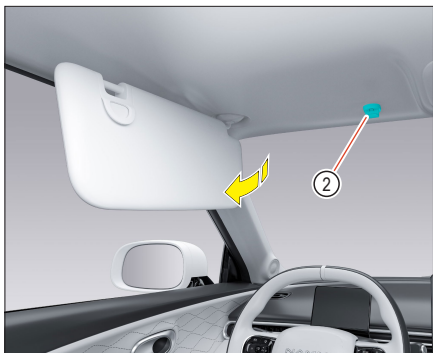

Detach the sun visor from the central support ② and turn it to the side to block glaring light coming from the side.

Large Vanity Mirror

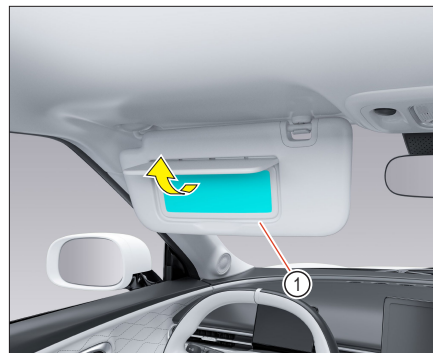

The vanity mirror is located on the back of the sun visor. Flip down the sun visor ① to use the vanity mirror.

CAUTION

If the driver needs to move the sun visor to the side while driving, they should observe the distance to the vehicles ahead and behind, and either slow down or stop the vehicle before operating. Since moving the sun visor can temporarily obstruct the driver's view, this should be done with caution.

Front Center Console Storage Box



The storage box located at the front of the center console can be used for storing items.

Trunk



The trunk can accommodate larger and heavier items. Please observe the following safety measures:

1. Place items with their center of gravity close to the floor and the back of the rear seats.
2. Keep hard items close to the back of the rear seats.
3. Ensure that items do not prevent the trunk door from closing normally.
4. It's advisable to securely tie down stored items.
5. Regularly clean out the trunk to reduce load and decrease energy consumption.
6. Folding down the rear seats can provide more storage space.

⚠ WARNING

- Do not store liquid, fragile, or dangerous items in the trunk.
- When children are around the vehicle, pay close attention to prevent them from being locked in the trunk while playing, which could cause serious harm. When not in use, close the trunk door, lock the vehicle, and keep the car keys out of children's reach.

Storage Devices

Horn Switch

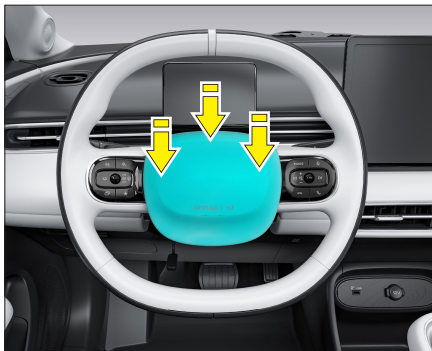

Pressing and holding any one of the three positions shown in the illustration will activate the horn. Releasing the horn switch will stop the horn from sounding.

The horn can operate as long as the 12V battery has power.

5. In-Vehicle Infotainment

Precautions.....	170
Safety and Attention	170
Audio-visual system.....	171
Home Display	171
Vehicle Settings.....	173
Application Center.....	177
Air Conditioning.....	179

Precautions

Safety and Attention

- Please read this manual and related materials carefully before using the system. Product images in the manual are for reference only; please refer to the actual product.
 - Before starting to use the audio-visual entertainment system, please remove the protective film from the screen.
 - Do not operate this system while driving, as it may lead to distraction and cause an accident. It is recommended to stop the car in a safe place before watching videos or operating the system.
 - Ensure the system is protected against water, moisture, and corrosion by liquids such as sulfuric acid to avoid affecting its normal use.
 - Do not use any hard objects to rub or hit the screen to protect the display effect.
 - When the main unit panel and LCD screen are dirty, wipe them with a soft cloth and neutral detergent. Wiping with alcohol or other solvents may cause panel scratches or text disappearance.
 - When the vehicle is being repaired, please turn off the audio-visual host and then disconnect the main power supply.
1. Due to different charging methods, the USB interface only supports charging for some phones;
 2. Each phone requires different charging currents, and charging with a non-professional charger may shorten the battery life and result in less than ideal charging efficiency;
 3. Each phone consumes power differently, and standby time may be shortened after charging with a non-professional charger.
- Special note: Due to the diversity of internal protocols in USB drives and the compression of audio and video files, the USB drive you have may not work normally with this system. It is recommended to use brand products supported by this system.
 - Please ensure that this system is kept away from hazardous materials.
 - Use this system reasonably while the vehicle is in motion to avoid affecting driving.
 - Use this system reasonably under complex road conditions to avoid affecting its performance.
 - If the car is parked under direct sunlight and the interior temperature is high, it is suggested to cool it down before using the system.
 - When replacing the fuse of this system, be sure to use a fuse of the same specification (current rating). Do not use a different fuse or other wires instead, as it may cause serious damage to the system.
 - This system is composed of precision components; do not disassemble any parts on your own. For repairs, please go to a specialty store.

Home Display

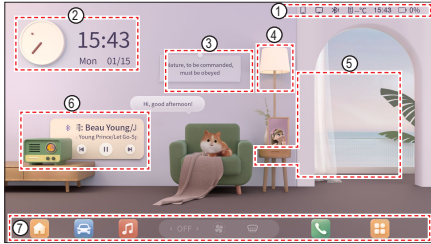

① Top Status Bar

Under normal circumstances, a row of icons will be displayed at the top of the screen, showing the status information of other function icons.

② Time and Date Display Widget

③ Personal Status Widget

Displays personal status tags; clicking pops up the status selection dialog, where you can choose your personal status for today or customize today's signature or memo.

④ Ambient Light Quick Adjustment Widget

Displays the ambient light widget; slide left and right to quickly turn on the ambient light and adjust the brightness; clicking the widget pops up the ambient light color adjustment dialog for quick adjustment of the light color.

⑤ Application Drawer

Customizable to place commonly used apps in the drawer for quick access and opening from the home page.

⑥ Music Quick Access Widget

This area permanently displays the currently playing music or radio; shows the source information and allows quick switching of tracks & play/pause; clicking enters the details of the currently playing media.

⑦ Bottom Navigation Bar

Buttons to return to the home interface, vehicle control, multimedia, air conditioning/seating, Bluetooth phone, and all applications menu interface.

NOTE

- The vehicle machine system will be continuously updated. The illustrations carried are the effect pictures of the factory version. After the system is updated, there will be slight changes. Please refer to the display of the actual vehicle version for content.

Top Status Bar

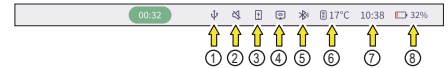

① USB Connection

-Displayed when USB is connected; clicking also opens file management.

② Mute

-Displayed when muted.

③ Mobile Wireless Charging

-Displays the status of mobile wireless charging; clicking opens the wireless charging switch.

④ Mobile Screen Casting

-Displays the status of mobile screen casting; clicking opens the mobile screen casting settings dialog.

Audio-visual system

⑤ Bluetooth

-Displays the Bluetooth connection status; clicking also opens the Bluetooth settings dialog.

⑥ External Temperature

-Displays the external temperature.

⑦ Time

- Display Time.

⑧ Battery Life

-Displays the power battery level.

Bottom Status Bar



① Return to Home

- Click to return to the home interface from any page.

② Vehicle Control

- Click to enter the vehicle control interface.

③ Multimedia

- Click to enter the multimedia interface.

④ Air Conditioning Temperature Control

- Click to control the set temperature of the air conditioning.

⑤ Air Conditioning Air Volume

- Click the air conditioning air volume button or swipe up from the bottom of the screen to bring up the air conditioning control interface.

⑥ Front Windscreen Defogging Button

- Click to turn on or off the front windscreen defogging.

⑦ Bluetooth Phone

- Click to enter the Bluetooth phone interface.

⑧ All Applications Menu

- Click to enter the all applications menu interface.

Pull-Down Quick Access Menu Interface

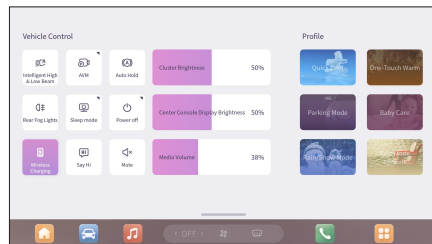

Swipe down from the top of the display screen to pull down the quick access menu interface.

In the pull-down quick access menu interface, you can make quick settings for vehicle control and profile modes.

- Vehicle control includes quick settings such as ESC OFF / Intelligent High & Low Beam, Parking Brake/Panoramic Imaging, Auto Hold, Instrument Cluster Brightness, Rear Fog Light, Sleep Mode, Power Off, Center Console Display Brightness, Wireless Charging, Say Hi, Mute, Media Volume, etc.
- Profile modes include quick settings such as Quick Cool, One-Touch Warm, Parking Mode, Baby Care, Rain/Snow Mode, Rest Mode, etc.

Vehicle Settings

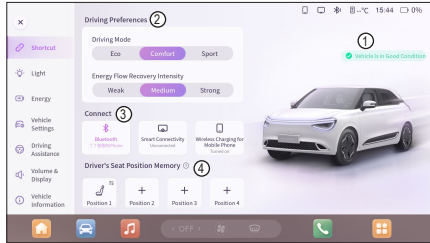

Shortcut

- ① Vehicle Health Status Display
-Displays the current vehicle status; clicking shows the vehicle health query dialog.
- ② Driving Preference Function Quick Control
-Toggle to quickly control the driving mode and energy flow recovery intensity by clicking.
- ③ Vehicle Connection Function Quick Settings
-Quick settings for Bluetooth connection, Smart Connectivity, and Wireless charging for Mobile Phone switch.
- ④ Driver's Seat Position Memory Function*
-This function is an optional feature; you can directly click to call up the set memory position of the main driver's seat. You can also click "+" to save the current position as a new seat position and customize the name.

Light - Exterior Lights

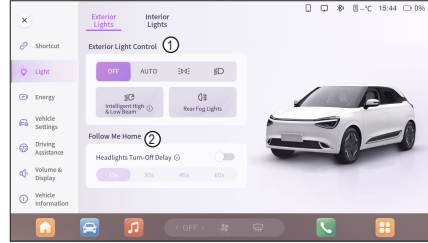

In the Lights→Exterior Lights interface→Exterior Light Control Options Bar ①, you can set the exterior headlights: Off, AUTO, Position Light, Low Beam, and Rear Fog Light. Some models can also set the Intelligent High Beam*.

In the Lights→Exterior Lights interface→Follow Me Home Options Bar ②, you can set the headlights turn-off delay: On, Off, and select the delay off time.

Light - Interior Lights



In the Lights→Interior Lights interface→Ambient Light Options Bar ①, you can set the ambient lights: Close, ON, and Auto. You can also adjust the brightness of the ambient light and set the color of the ambient light.

Audio-visual system

Energy - Charging

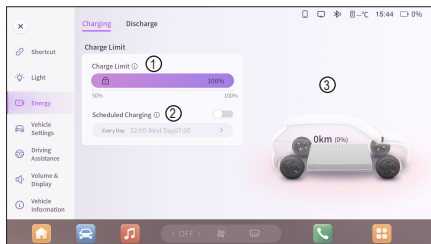

In the Energy → Charging interface → Charge Limit Options Bar, slide ① left and right to set the charge limit, with an adjustment range of 50% to 100%, and the battery's dashed line shows the current set SOC value.

In the Energy → Charging interface → Charge Limit Options Bar, touch ② to turn on/off the scheduled charging function, set the charging time, and set the charging limit. If the end time is less than or equal to the start time, the default end time is the next day, and the end time displays the "Next Day" identifier.

In the Charging Status Information Area ③, you can display key information and operation buttons such as the current vehicle plug-in and charging status, accompanied by different visual effects reflecting the vehicle battery and charging status.

Energy - Discharge*

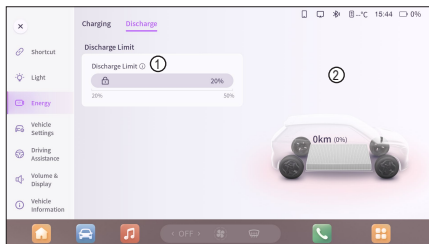

In the Energy → Discharging interface → Discharge Limit Options Bar, slide ① left and right to set the discharge limit, with an adjustment range of 20% to 50%. When the battery reaches the limit, a pop-up will prompt "Remaining battery has reached the discharge limit, stop discharging".

In the Discharge Status Information Area ②, you can display key information and operation buttons such as the current vehicle's external devices and discharge status, accompanied by different visual effects reflecting the vehicle battery and discharge status.

Vehicle Settings

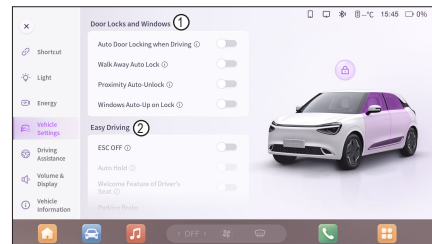

In the Vehicle Settings → Door Locks and Windows Options Bar ①, you can control the door lock and window functions: Auto Door Locking When Driving Switch, Walk Away Auto Lock* Switch, Proximity Auto-Unlock* Switch, Windows Auto-Up on Lock Switch.

In the Vehicle Settings → Easy Driving Options Bar ②, you can set convenient driving functions: ESC OFF, Auto Hold*, Welcome Feature of Driver's Seat*, Parking Brake.

In the Vehicle Settings → Steering Wheel Custom Button Options Bar, you can set the steering wheel custom buttons to quickly open the corresponding functions: 360 Panoramic View, One-Click Air Conditioning On, Play and Pause, Say Hi.

Driving Assistance



In the Driving Assistance→Lane Assist Options Bar ①, you can set the corresponding lane keeping assistance function to turn on/off and set it through the function switch. Select "Alertm" to sound a warning when unintentionally departing from the lane; select "Correction" to assist in steering when unintentionally departing from the lane.

In the Driving Assistance→Collision Assist Options Bar ②, you can set the corresponding collision assistance function to turn on/off and set it through the function switch. "Side Obstacle Monitoring" and "Front Obstacle Monitoring" are optional features.

In the Driving Assistance→Intelligent Recognition Options Bar, you can set the corresponding Intelligent recognition functions (Intelligent Speed Assistance, Speed Deviation Setting, and Traffic Sign Recognition) to turn on/off and set them through the function switch.

Volume & Display - Sound Effects

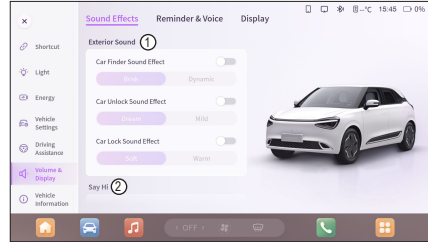

In the Volume & Display→Sound Effects interface→Exterior Sound Options Bar ①, you can set exterior sounds: Car Unlock Sound Effect, Car Lock Sound Effect.

In the Volume & Display→Sound Effects interface→Say Hi Options Bar ②, after parking, you can touch the switch inside the car to play Say Hi sound effects outside, with 4 types of sound effects available.

In the Volume & Display→Sound Effects interface→Volume Setting Options Bar, you can set the following volumes: Multimedia Volume.

In the Volume & Display→Sound Effects interface→Sound Effect Setting Options Bar, you can set the following sound effects: Volume Balance, Speed Volume Compensation, Screen Button Sound, Loudness Compensation Control, and Equalizer.

Volume & Display - Reminder & Voice

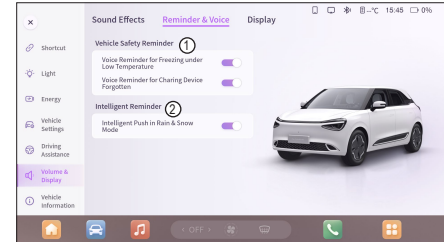

In the Volume & Display→Reminder & Voice→Vehicle Safety Reminder Options Bar ①, you can set the following alert sounds: Seat Belt Not Fastened Alert Sound, and Low Temperature Frost Alert Sound.

In the Volume & Display→Reminder & Voice→Intelligent Reminder Options Bar ②, you can set the following Intelligent reminder: Intelligent Push in Rain & Snow Mode.

Audio-visual system

Volume & Display - Display

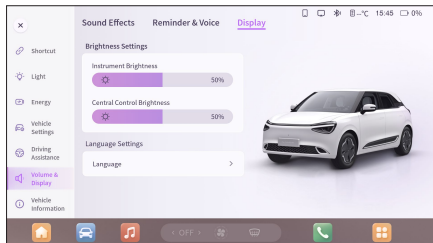

In the Volume & Display→Display interface→Brightness Settings Options Bar, you can set the following brightness: Brightness Mode (Auto, Day, Night), Instrument Brightness, and Central Control Brightness.

Volume & Display - Display

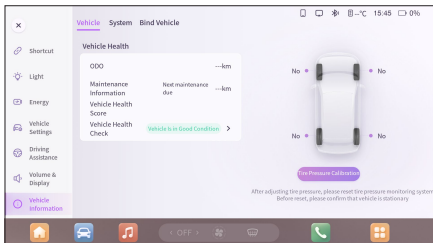

In the Vehicle Information→Vehicle interface→Vehicle Health Options Bar, you can query the vehicle's information: Total Mileage, Maintenance Information, Vehicle Health Score, Vehicle Health Check.

Vehicle Information - System

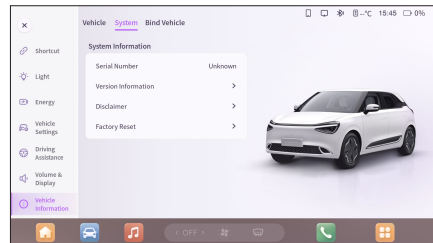

In the Vehicle Information→System interface→System Information Options Bar, you can query system information: Serial Number, Version Information, Disclaimer, and Factory Reset.

Application Center

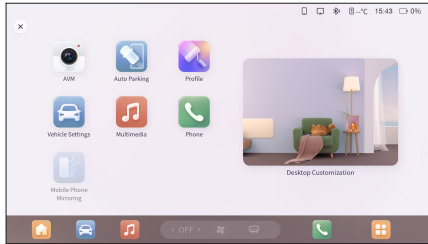

Application Center includes: Panoramic View*, Automatic Parking*, Profile Mode, Vehicle Settings, Multimedia, Telephone, and Mobile Mirroring.

Profile Mode

Quick Cool

After selecting "Quick Cool", the air conditioning will automatically start cooling, setting the temperature to the lowest.

One-Touch Warm

After selecting "One-Touch Warm", the air conditioning will automatically start heating, and the seat heating will be activated.

Parking Mode

After selecting "Parking Mode", the windows, air conditioning, and wipers will automatically close. Please do not approach the windows.

Baby Care

After selecting "Baby Care", the air conditioning will automatically adjust to baby comfort mode, and multimedia volume will be lowered.

Rain/Snow Mode

After selecting "Rain/Snow Mode", the low beam, fog lights, position lights, and front defroster will automatically turn on. Please be cautious in rainy and snowy weather.

Custom Mode

After selecting "Custom Mode", you can create a custom profile mode, setting air conditioning flow, temperature, internal/external circulation, blowing mode, air quality adjustment inside the vehicle, front windshield defrosting, rear windshield heating, seat heating, seat ventilation, music type, and ambient light settings.

Rest Mode

After activating "Rest Mode", you can set the rest duration and rest mode parameters (air conditioning, airflow, temperature, in-car air conditioning adjustment, music, ambient light brightness, central control screen brightness, ceiling light, etc.).

Audio-visual system

Desktop Customization Settings

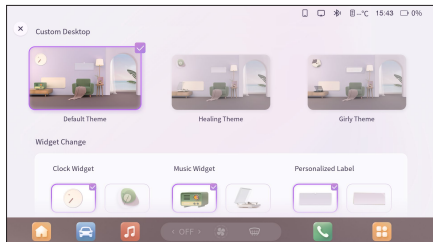

Tap on the Desktop Customization to enter settings: Desktop Customization (Default Theme, Healing Theme, Girl Theme), Gadget Replacement (Clock Widget, Music Widget, Personalized Label).

Multimedia - BT Music



① Current Connected Device Information

Shows the information of the currently connected device. Clicking on the Bluetooth music page allows for device switching.

② Song Cover

Fixed display of the current playing song's cover. If the song cover is not recognized, a default cover image is displayed.

③ Song Name & Artist Name

Displays the current playing song name & artist name. If the song name is too long, it scrolls; if the artist name is too long, ellipses are shown.

④ Song Lyrics

Displays the current playing song's lyrics. If the lyrics file/music file is not recognized, a

prompt message is displayed.

⑤ Previous Song

Click to play the previous track.

⑥ Play / Pause

Click to play or pause the track.

⑦ Next Song

Click to play the next track.

Multimedia - USB Music

Function Operation Reference: Bluetooth Music.

Bluetooth Phone

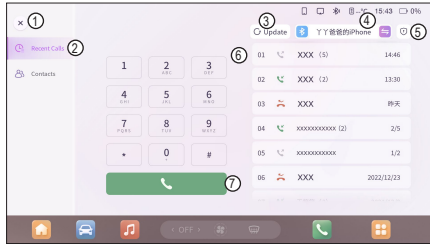

① Page Close Button

Click to close the page and return to the homepage with one click.

② Switch Telephone Function Button

Click to switch to other telephone function modules: Recent Calls/Contacts.

③ Update Contacts

Click to synchronize the latest status of the mobile phone contacts to the car machine. During the update, the status cannot be interrupted and cannot be clicked repeatedly.

④ Current Connected Device Information

Fixed display of the current connected device name. Click to open the Bluetooth settings

popup for device switching.

⑤ Privacy Mode

Click to turn on or off the privacy mode feature, with a popup message appearing (which automatically closes after 3s).

Privacy mode affects network calls. When activated, sound is only played on the mobile phone, and the network call status is not displayed on the car machine end.

⑥ Call History

When no number is input by the user, this area displays the call history. A maximum of 200 historical call records are displayed, sorted by time, with the most recent call at the top.

Call information includes outgoing/incoming/missed calls, user names, and call times.

Call history is updated after connection and call completion. Exceeding 200 records will automatically delete the earliest record based on the first-in-first-out principle.

If there is no call record, a blank state is displayed, with a prompt indicating no call record.

⑦ Dial Button

When no number is entered, clicking the dial button has no response. With a number entered, clicking will initiate a call regardless of the number input.

Audio-visual system

Air Conditioning

Electric Air Conditioning Interface



- 1.Call up the air conditioning panel (shortcut bar)
- 2.Temperature control (shortcut bar)
- 3.Front windshield defogging (shortcut bar)
- 4.Temperature control
- 5.Internal/external circulation switch
- 6.Auto internal/external circulation switch
- 7.Airflow control
- 8.Driver's seat ventilation
- 9.Driver's seat heating
- 10.Scheduled Departure (timed air conditioning)
- 11.Blowing mode selection
- 12."A/C" air conditioning button
13. Air Conditioning Off Button
14. One-Button Rapid Cooling
15. Rear Window/Side Mirror Defrosting
16. Front Windshield Defogging Button

Electric Air Conditioning Interface



- 1.Call up the air conditioning panel (shortcut bar)
- 2.Temperature control (shortcut bar)
- 3.Front windshield defogging (shortcut bar)
- 4.Temperature control
- 5.Internal/external circulation switch
- 6.Auto internal/external circulation switch
- 7.Airflow control
- 8.Driver's seat ventilation
- 9.Driver's seat heating
- 10.Scheduled Departure (timed air conditioning)
- 11.Blowing mode selection
- 12."A/C" air conditioning button
13. Air Conditioning Off Button
14. Automatic Air Conditioning Switch
15. Rear Window/Side Mirror Defrosting
16. Front Windshield Defogging Button
17. One-Button Rapid Cooling

6. Emergency Situations

Onboard Tools	182	Powertrain Compartment Fuse Box	
Hazard Warning Lights	182	Description	187
Hazard Warning Lights	182	Cabin Fuse Box	190
Onboard Tools	182	Cabin Fuse Box Description	191
Triangular Warning Sign	183	Bulb Replacement	193
Use of the Triangular Warning Sign	183	Light Parameters	193
Emergency Tire Repair	184	Jump Starting	194
Precautions for Using Tire Repair Tools	184	General Description	194
Method of Emergency Tire Repair	184	Steps for Jump Starting	195
Storing Tools	184	Towing a Trailer	197
Fuse Replacement	185	Precautions	197
Powertrain Compartment Fuse Box	185	Methods of Towing	197
Cabin Fuse Box	185	Incorrect Towing Examples	198
Checking and Replacing Fuses	185		
Powertrain Compartment Box	186		

Hazard Warning Lights



The hazard warning light switch is located on the front overhead light switch panel. In emergency situations, use the hazard warning lights to alert other road users, helping to avoid traffic accidents.

After pressing the hazard warning light switch, all turn signal lights will flash simultaneously, and both turn signal indicators on the combination instrument panel will also flash.

To turn off the hazard warning lights, press the hazard warning light switch again.

The hazard warning lights should be turned on in the following situations:

1. When the vehicle breaks down due to technical failure.
2. When the vehicle is at the end of a traffic jam.
3. In emergency situations.
4. When towing another vehicle or being towed.

CAUTION

- When the READY light is off, do not keep the hazard warning lights on for an extended period without a special need, to avoid draining the 12V battery.
- When the hazard warning light switch is on, it cannot clearly indicate the vehicle's turning intentions. In this case, pay special attention, temporarily turn off the hazard warning light switch before using the turn signals.
- In the event of a collision, the hazard warning lights may automatically turn on.

Automatic Activation During Emergency Braking

When ABS is activated and the brake pedal is pressed hard for emergency braking, causing the vehicle to decelerate to a certain value, the hazard warning lights may automatically turn on, with all turn signal indicators flashing simultaneously. When the brake pedal is released and the vehicle continues to drive, the hazard warning lights will turn off.

Onboard Tools

Storage Location of Onboard Tools

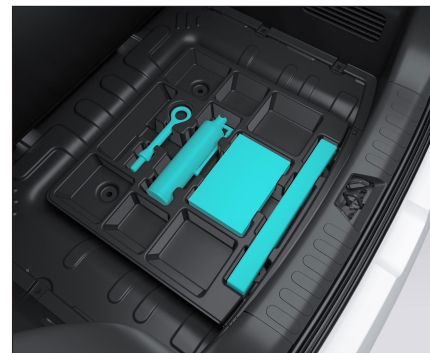

The onboard tools are stored under the foam pad beneath the trunk floor and fixed behind the rear panel. They can be accessed by lifting the trunk floor.

The set includes a triangular warning sign, a tire repair kit, and a towing hook.

Use of the Triangular Warning Sign

Storage Location of the Triangular Warning Sign

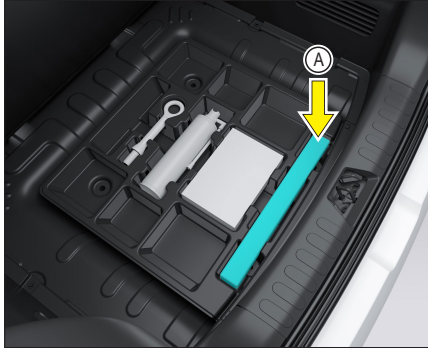

The triangular warning sign is stored under the foam pad A beneath the trunk floor (A). Lift the trunk floor handle and open the trunk floor to access it.

According to legal regulations, when a vehicle cannot leave the driving lane due to a breakdown, accident, or other reasons, or when parking on the shoulder, the hazard warning lights must be turned on, and a triangular warning sign should be set up in the direction of oncoming traffic to alert following vehicles.

How to Deploy the Triangular Warning Sign

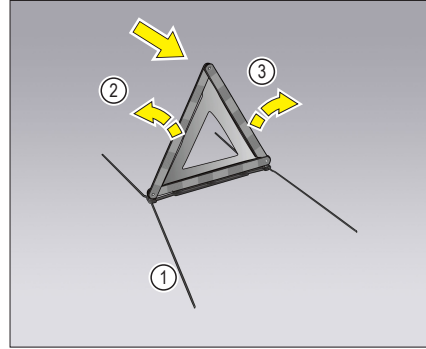

1. Open the four base supports ①;
2. Open the two folding sides of the reflector ② and ③ and lock the top end;
3. During use, place the base on the ground and position the side with reflective material facing rearward.

After use, fold it back in the reverse order and store it properly.

When folding it back, apply force on the upper area of the two reflector plates. Slightly force the side with the reflective material to easily separate the two reflector plates and avoid damage.

Placement Distance of the Triangular Warning Sign



	Ordinary Roads	Highways
Placement Distance L	50~100m	≥ 150m

CAUTION

When placing the triangular warning sign, ensure the side with reflective material faces rearward.

Emergency Tire Repair

Precautions for Using Tire Repair Tools

Emergency tire repair tools should only be used as a temporary solution for tire repair. You still need to replace or repair the faulty tire as soon as possible. Do not use quick tire repair tools when the tire sidewall is damaged, the wheel is damaged, or the cut is too large.

Please read the following safety instructions to use the tire repair tools safely and correctly.

Wear gloves and take appropriate protective measures to prevent injury when using tire repair tools.

WARNING

- Ensure the vehicle is securely parked and the electronic gear lever is in the "P" position.
- Do not use tire repair tools if there is heavy traffic close to the broken-down vehicle. Instead, contact professional road assistance personnel.
- All passengers must leave the vehicle and wait in a safe location.

CAUTION

The following situations are not suitable for using the emergency tire repair kit. Contact a dealership or road assistance:

- When the tire repair fluid exceeds its expiration date;
- When the tire is damaged due to driving with a significant air leak;
- When there is a sidewall rupture or blowout;
- When there are cuts or punctures larger than 4 mm on the tire surface;
- When the tire is visibly detached from the rim;
- When the rim is damaged;
- When there are blowouts in two or more tires.

Method of Emergency Tire Repair

Follow the instructions attached to the accompanying air pump.

WARNING

If the tire pressure cannot be restored to normal after repair, it indicates that the tire is severely damaged and cannot be repaired. Please immediately stop the vehicle safely and contact the dealership.

WARNING

- After emergency tire repair, you should immediately drive for 5km (starting with 200m, the speed should be less than 50km/h, then continue at a speed not exceeding 80km/h). If the tire pressure is less than 2.0 bar, please immediately contact road assistance and proceed to the nearest dealership.
- If you need to repair or reuse the tire after emergency tire repair, please contact a dealership.

Storing Tools

1. Properly store the used tools in the storage area under the trunk floor and cover the trunk floor;
2. Collect and store the triangular warning sign;
3. Close the trunk door.

CAUTION

After repairing the tire, ensure that the tools are properly stored. Otherwise, these items can be thrown out in the event of an accident or emergency braking, causing danger.

Powertrain Compartment Fuse Box

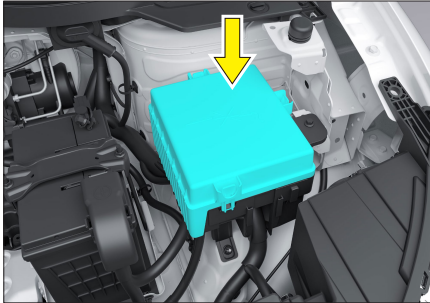

The powertrain compartment fuse box is located next to the 12V battery. Opening the fuse box cover will reveal the fuses.

The cover of the fuse box has corresponding fuse number.

Cabin Fuse Box



The cabin fuse box can be accessed by removing the cover panel located on the lower left side of the dashboard.

Checking and Replacing Fuses

If an electrical device in the car stops working, the first step is to check if it's due to a blown fuse. Use the fuse information to determine which fuse or fuses control that component.

If it's unclear which blown fuse might be causing the issue, replace all damaged fuses and check if the electrical device operates normally. If the fault persists, contact a dealership for repair.

CAUTION

- Do not use fuses with higher or lower amperage values than those specified on the fuse box, as this can damage the electrical system or cause a fire.
- If a blown fuse is replaced with a spare fuse of a lower ampere rating and the fault is resolved, replace it as soon as possible with a fuse of the correct rating.

Fuse Replacement

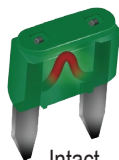

Intact

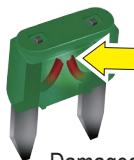

Damaged

Remove the fuse corresponding to the non-functioning electrical device and check if the metal wire inside the fuse is blown . If it's blown(as shown by the arrow in the illustration), replace it with a spare fuse of the same or lower amperage.

If a replacement fuse of the same rating blows again soon after, this indicates a serious electrical fault in the vehicle. Do not use the faulty electrical device, leave the blown fuse in the fuse box, and contact a dealership for repair.

i NOTE

If the vehicle cannot be moved due to a lack of spare fuses, a fuse of the same or lower amperage can be temporarily borrowed from another circuit. However, ensure that the device corresponding to that circuit is not used and does not affect driving.

Powertrain Compartment Box

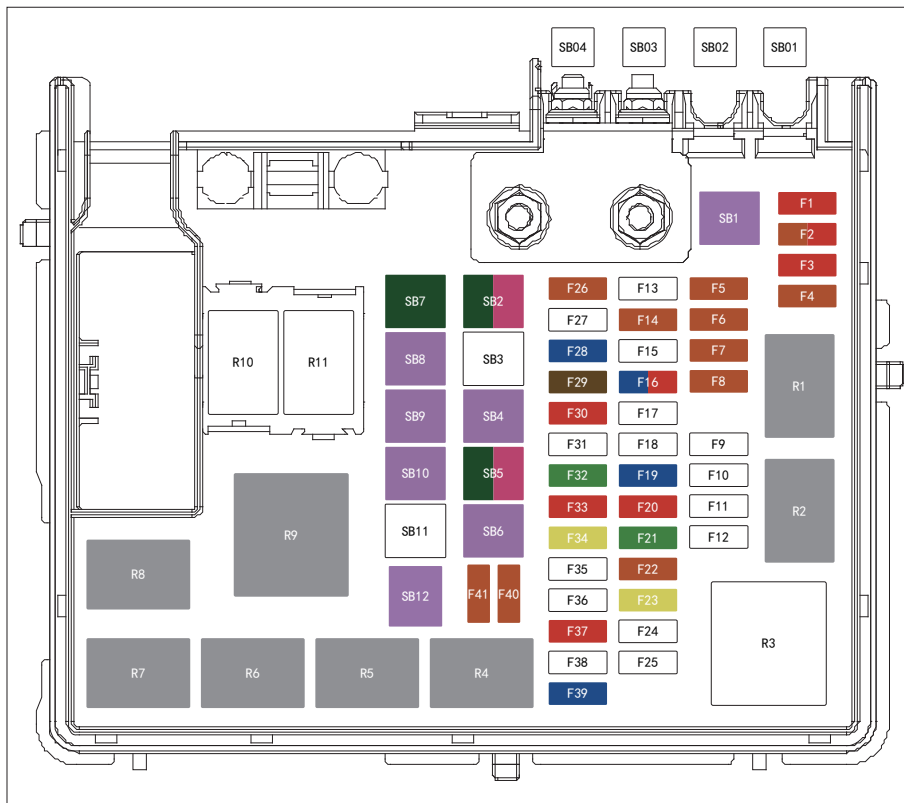

Powertrain Compartment Fuse Box Description

Name	Type	Specification	Function	Configuration
SB01	MIDI	60A	Cooling Fan Electronic Control Box B+ Supply	ALL
SB02	MIDI	80A	IPJB B+ Supply	ALL
SB03	MIDI	80A	EPS B+ Supply	ALL
SB04	MIDI	Reserved	-	-
SB1	JCASE	ST	EJB IG1 Supply	ALL
SB2	JCASE	40A	ESC ECU and Coil B+ Supply	ESC Configuration
SB2	JCASE	60A	IBC KL30_V B+ Supply	IBC Configuration
SB3	JCASE	Reserved	-	-
SB4	JCASE	30A	Window Anti-Pinch Controller B+ Supply 2	ALL
SB5	JCASE	40A	ESC Motor B+ Supply	ESC Configuration
SB5	JCASE	60A	IBC KL30_M B+ Supply	IBC Configuration
SB6	JCASE	30A	Rear Defroster Relay Contact B+ Supply	Heated Mirrors Configuration
SB7	JCASE	40A	R9 IG2 Relay Contact B+ Supply	ALL
SB8	JCASE	30A	Window Anti-Pinch Controller B+ Supply 1	ALL
SB9	JCASE	30A	R7 Electric Vacuum Pump Relay Contact B+ Supply	ESC Configuration
SB10	JCASE	30A	Driver's Seat B+ Supply	Electric Main Driver Seat Heating and Ventilation Configurations
SB11	JCASE	Reserved	-	-
SB12	JCASE	ST	Air Conditioning Blower IG2 Supply	ALL
F1	MINI	10A	Left Front Combination Light Supply; Left Front Low Beam Supply	ALL
F2	MINI	5A	Right Rear Combination Light Supply	Welcome Light Projection Configuration
F2	MINI	10A	Right Front Low Beam Supply	Halogen Headlights Configuration
F3	MINI	10A	Right Front Combination Light Supply	Welcome Light Projection Configuration
F4	MINI	5A	Left Rear Combination Light Supply	Welcome Light Projection Configuration

Fuse Replacement

Name	Type	Specification	Function	Configuration
F5	MINI	5A	ESC/IBC Controller IG1 Supply	ALL
F6	MINI	5A	PDCU, BMS IG1 Supply	ALL
F7	MINI	5A	Vehicle Warning Sound Controller IG1 Supply; Headlight Leveling IG1 Supply	ALL
F8	MINI	5A	OBC&DCDC/Compressor Controller IG1 Supply	ALL
F9	MINI	Reserved	-	-
F10	MINI	Reserved	-	-
F11	MINI	Reserved	-	-
F12	MINI	Reserved	-	-
F13	MINI	Reserved	-	-
F14	MINI	5A	Cooling Fan Control Box B+ Supply	ALL
F15	MINI	Reserved	-	-
F16	MINI	15A	Rear Wiper B+ Supply	Body Control Module Configuration
F16	MINI	10A	R7 Front Washer Relay Contact B+ Supply	Central Control Module Configuration
F17	MINI	Reserved	-	-
F18	MINI	Reserved	-	-
F19	MINI	15A	Motor Water Pump Relay Contact and Coil B+ Supply	ALL
F20	MINI	10A	BMS, PDCU B+ Supply 1	ALL
F21	MINI	30A	BCM/CCM External Light Power 3	ALL
F22	MINI	5A	R7 Electric Vacuum Pump Relay Coil B+ Supply	ESC Configuration
F23	MINI	20A	BCM/CCM External Light Power 1	ALL
F24	MINI	Reserved	-	-
F25	MINI	Reserved	-	-
F26	MINI	5A	R1 Wiper Main/R2 Wiper High Speed/R7 Front Washer/R6 Horn Relay Coil B+ Supply	ALL
F27	MINI	Reserved	-	-

Name	Type	Specification	Function	Configuration
F28	MINI	15A	BCM/CCM External Light Power 2	ALL
F29	MINI	7.5A	Horn Relay Contact B+ Supply	ALL
F30	MINI	10A	OBC&DCDC B+ Supply	ALL
F31	MINI	Reserved	-	-
F32	MINI	30A	Wiper Main Relay Contact 4 B+ Supply	ALL
F33	MINI	10A	BMS, PDCU B+ Supply 2	ALL
F34	MINI	20A	R5 Low Beam Relay Contact and Coil B+ Supply	ALL
F35	MINI	Reserved	-	-
F36	MINI	Reserved	-	-
F37	MINI	10A	Brake Light Switch B+ Supply	ALL
F38	MINI	Reserved	-	-
F39	MINI	15A	R8 High Beam Relay Contact and Coil B+ Supply	Welcome Light Projection Configuration
F40	MINI	5A	Headlight Leveling Supply; Front Through Light Supply	ALL
F41	MINI	5A	BCM/CCM IG2 Feedback Input	ALL
R1	Micro	35A	Wiper Main Relay	ALL
R2	Micro	35A	Wiper High Speed Relay	ALL
R3	Micro	Reserved	-	-
R4	Micro	35A	Cooling Water Pump Relay	ALL
R5	Micro	35A	Low Beam Relay	ALL
R6	Micro	35A	Horn Relay	ALL
R7	Micro	35A	Electric Vacuum Pump Relay	ESC Configuration
R7	Micro	35A	Front Washer Motor Relay	Central Control Module Configuration
R8	Micro	35A	High Beam Relay	Welcome Light Projection Configuration
R9	MINI	40A	IG2 Blower Relay	ALL
R10	Micro	Reserved	-	-
R11	Micro	Reserved	-	-

Fuse Replacement

Cabin Fuse Box

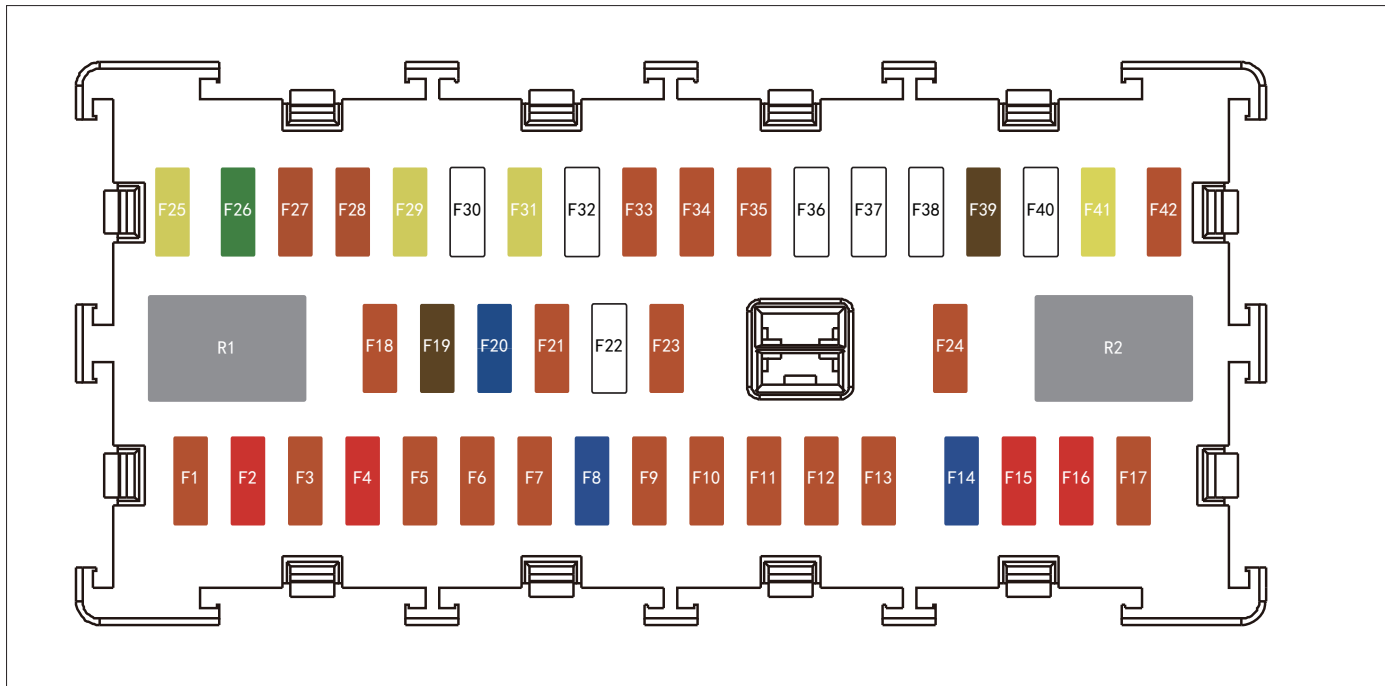

Cabin Fuse Box Description

Name	Type	Specification	Function	Configuration
F1	MINI	5A	MP5, Combination Instrument IG1 Supply	ALL
F2	MINI	5A	ETC, Combination Switch, ADAS Camera, CCM/BCM Feedback Input, Parking Radar Controller, FAPA IG1 Supply	ALL
F3	MINI	5A	FAPA, Rearview Mirror Adjustment Switch IG1 Supply	ALL
F4	MINI	10A	Airbag Controller IG1 Supply	ALL
F5	MINI	5A	Four-Door Electric Window Switch Backlight IG1 Supply	ALL
F6	MINI	5A	Hidden Door Handle Controller IG1 Supply	Keyless Entry for Driver Configuration
F7	MINI	5A	Seat IG1 Supply	Electric Main Driver Seat Heating and Ventilation Configurations
F8	MINI	15A	EJB IG1 Supply	ALL
F9	MINI	5A	EPS IG1 Supply	ALL
F10	MINI	5A	Electric Air Conditioning Controller IG1 Supply	Electric Climate Control Single Zone Configuration
F11	MINI	5A	TU Remote Monitoring Module IG1 Supply	ALL
F12	MINI	5A	Brake Light Switch IG1 Supply	ALL
F13	MINI	5A	Headlight Adjustment Switch IG1 Supply	ALL
F14	MINI	15A	12V Power Outlet IG3 Supply	ALL
F15	MINI	10A	Dashcam, Driver's USB, Passenger's USB IG3 Supply	ALL
F16	MINI	10A	Mobile Phone Wireless Charger IG3 Supply	TWLC01
F17	MINI	5A	BCM/CCM IG3 Feedback Input	ALL
F18	MINI	5A	Instrument Cluster, Air Conditioning Stepper Motor, Combination Switch B+ Supply	ALL
F19	MINI	7.5A	FAPA B+ Supply 1, ADAS Camera B+ Supply	FCW+AEB+ACC+LDW+LKA+Auto Parking
F20	MINI	15A	MP5 B+ Supply	ALL
F21	MINI	5A	OBD B+ Supply	ALL

Fuse Replacement

Name	Type	Specification	Function	Configuration
F22	MINI	Reserved	-	-
F23	MINI	5A	Vehicle Warning Sound Controller Supply	With Mobile Connectivity Configuration
F24	MINI	5A	Electric Air Conditioning Controller Supply	Electric Climate Control Single Zone Configuration
F25	MINI	20A	Hidden Door Handle Controller Supply	With Mobile Connectivity Configuration
F26	MINI	30A	Main Fuse for Busbar Terminals	ALL
F27	MINI	5A	FAPA B+ Supply 2	Auto Parking Configuration
F28	MINI	5A	Left Front Door Window Switch, Left Front Door Handle Switch B+ Supply	ALL
F29	MINI	20A	BCM/CCM Interior Light B+ Supply	ALL
F30	MINI	Reserved	-	-
F31	MINI	20A	Controlled Power Supply Relay Contact B+ Supply	ALL
F32	MINI	Reserved	-	-
F33	MINI	5A	Rear Defroster Relay Coil, Controlled Power Supply Relay Coil B+ Supply	ALL
F34	MINI	5A	Window Anti-Pinch Controller B+ Supply	ALL
F35	MINI	5A	TU Remote Monitoring Module B+ Supply	ALL
F36	MINI	Reserved	-	-
F37	MINI	Reserved	-	-
F38	MINI	Reserved	-	-
F39	MINI	7.5A	CCM Air Conditioning, CCM Rearview Mirror Folding B+ Supply	Central Control Module Configuration
F40	MINI	Reserved	-	-
F41	MINI	20A	BCM/CCM Door Lock B+ Supply	ALL
F42	MINI	5A	Rearview Mirror Heater Supply	Heated Mirrors Configuration
R1	Micro	35A	IGN1 Relay	ALL
R2	Micro	35A	IGN3 Relay	ALL
D1721	Micro	35A	Rear Defrost Relay	Heated Mirrors Configuration
D1721A	Micro	35A	Controlled Power Supply Relay	ALL

Light Parameters

Light Name		Models with Through Light			
		Quantity	Color	Power/W	Model
Front Combination Lights	High Beam/Low Beam	2/3	White	42/24	LED
	Daytime Running Lights	5	White	19	LED
	Position Lights		White	2.7	LED
	Turn Signals	4	Amber	16	LED
Through Lights	Position Lights	4	White	4.5	LED
Rear Combination Lights	Turn Signals	2	Amber	21	PY21W
	Rear Position Lights	2	Red	2.6	LED
	Brake Light	2	Red	17.1	LED
Rear Fog Light		1	Red	21	P21W
Reverse Light		1	White	21	P21W
High-Mount Brake Light		1	Red	16	W16W
License Plate Light		2	White	5W×2	W5W

Jump Starting

General Description

If the vehicle cannot start due to an overly discharged 12V battery, it can be jump-started using another vehicle's 12V battery and jumper cables, while observing the following points:

- Ensure the supply 12V battery has a rated voltage of 12V and its capacity (Ah) is not less than the faulty vehicle's 12V battery.
- The clamps on the jumper cables must be insulated.

⚠ WARNING

- Explosive hydrogen gas may be present near the 12V battery. The battery must be kept away from sparks and open flames.
- The two vehicles should not touch each other during jump starting. Otherwise, as soon as the positive poles of both 12V batteries are connected, the current will be immediately connected, posing a danger.

👁 CAUTION

Before starting work on the 12V battery, carefully read and follow the safety warnings related to 12V battery operations.

Avoiding Static Electricity

Charging or jump starting the 12V battery can produce highly flammable mixed gases. Ensure that both you and the 12V battery do not accumulate static electricity. For example, the following actions can cause static electricity buildup:

1. Wearing synthetic fiber clothing.
2. Friction between clothing and the seat.
3. Dragging or pushing the 12V battery over carpet or other synthetic materials.
4. Wiping the 12V battery with a cloth.

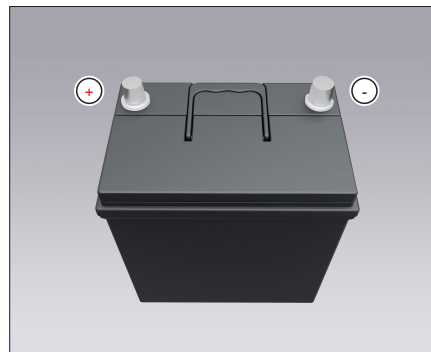

The battery terminal with a "+" sign is the positive pole, and the one with a "-" sign is the negative pole.

Steps for Jump Starting

1. If the rescue vehicle's 12V battery is far from the faulty vehicle's battery, park the vehicles closer to each other.
2. Engage the parking brake and put the gear in "P".
3. Power down the vehicle and turn off all electrical devices (such as lights, heating, air conditioning, etc.).
4. Cover the 12V battery with a dry cloth to reduce the risk of explosion.
5. Connect the red positive jumper cable as shown ① → ②. Be careful to avoid short circuits.
6. Connect the black negative jumper cable as shown ③ → ④. Be careful to avoid short circuits.
7. Start the faulty vehicle in the normal way and illuminate the READY light.
8. After starting the faulty vehicle, carefully disconnect the jumper cables in the reverse order of connection.
9. Properly dispose of the dry cloth to avoid pollution.

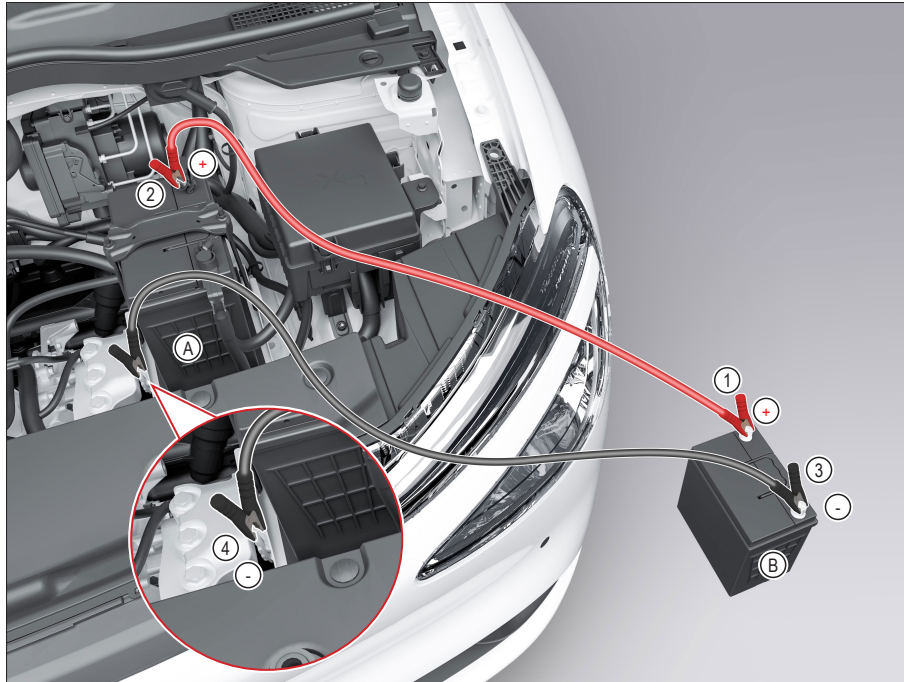

(A): Faulty Vehicle's 12V Battery

(B): Rescue Vehicle's 12V Battery

CAUTION

- Ensure that the positive poles (+) of both 12V batteries are connected. Do not connect the rescue vehicle's 12V battery negative pole (-) to the faulty vehicle's 12V battery negative pole (-); it should be connected to a grounding point on the faulty vehicle's body.
- Always use 12V battery for rescue. Use a rescue vehicle's 12V battery with a voltage higher than 12V could damage the vehicle's electrical equipment.
- When connecting or disconnecting jumper cables, completely connect or disconnect one cable before dealing with the other to avoid short circuits.
- Ensure the cable clamps do not contact any other metal.
- Open the blower or rear window glass heater of the faulty vehicle when disconnecting the jumper cables. It helps reduce the voltage peak generated during disconnection, preventing sparks.

WARNING

- Reversing the 12V battery poles during jump starting can damage the vehicle (such as fuses/relays/electrical controllers) and may even cause the 12V battery to explode.
- Incorrect jump starting can cause the 12V battery to explode. A battery explosion can cause serious injuries or death and can also damage the vehicle. Strictly adhere to the instructions in this section.
- Explosive hydrogen gas is always present near the 12V battery. The battery must be kept away from sparks and open flames.
- Do not connect the rescue vehicle's 12V battery negative pole (-) to the faulty vehicle's 12V battery negative pole (-) to avoid igniting flammable gases produced by the battery, leading to an explosion.
- Wear appropriate eye protection when working on or near the 12V battery, and remove rings, bracelets, and other jewelry.
- Avoid leaning over the 12V battery during jump starting to prevent acid burns.

WARNING

- Do not let battery acid contact your eyes, skin, clothing, or the vehicle's paintwork. Battery fluid is a corrosive sulfuric acid solution that can cause severe burns. If acid contacts any area, immediately flush the surface with plenty of water.
- Keep the 12V battery out of children's reach.
- The rescue vehicle's 12V battery must have a rated voltage of 12V. Using a battery with incorrect ratings can damage the vehicle.
- Do not attempt to jump-start a frozen 12V battery. It can explode, leading to serious accidents.

Precautions

When towing a vehicle, it's crucial to comply with local regulations. Improper towing methods can damage the vehicle. To ensure the correct towing method and protect the vehicle from accidental damage, it is recommended to use professional roadside assistance for towing. During towing, drivers and rescue personnel should pay attention to the following:

- Before towing, confirm that the decelerator, steering system, and transmission system are operational. If any of these systems are damaged, the vehicle must be loaded onto a flatbed recovery vehicle.
- Turn on the hazard warning lights when towing.
- Do not leave the vehicle keys inside the car.

Methods of Towing



It's recommended to use a flatbed tow truck as the primary method, where the vehicle is directly loaded onto the rescue vehicle. This is the best method for transporting a vehicle.

If the vehicle's wheels and axles are in good condition, the faulty vehicle's front (or rear) wheels can be secured to the rescue vehicle, and the rear (or front) wheels can be secured to a small trailer.

Towing a Trailer

Incorrect Towing Examples



WARNING

Under no circumstances should the vehicle be towed with the rear wheels on the ground, as it can cause serious damage to the power battery.



WARNING

Under no circumstances should the vehicle be towed with the front wheels on the ground, as it can cause serious damage to the drive motor and decelerator.



WARNING

Under no circumstances should the vehicle be towed with all four wheels on the ground, as it can cause serious damage to the drive motor and decelerator.

7. Maintenance

Maintenance Overview	200	Window Tinting Film for Car Windows* .	218
General Description	200	Choosing Window Tinting Film*	218
Daily Maintenance Items	201	Tires and Wheels.....	219
Daily Maintenance Precautions.....	201	Tire and Wheel Inspection.....	219
External Daily Maintenance Items.....	202	Tire Selection and Replacement	222
Internal Daily Maintenance Items.....	203	Handling a Blowout	224
Other Daily Maintenance Items.....	203	Rim Replacement.....	224
Powertrain Compartment Lid.....	204	Anti-Skid Chains.....	225
Opening/Closing the Powertrain		Vehicle Cleaning.....	226
Compartment Lid.....	204	Exterior Cleaning.....	226
Powertrain Compartment.....	206	Interior Cleaning.....	228
Powertrain Compartment Layout	206	Vehicle Corrosion Prevention	230
Safety Instructions for Working in the		Anti-Corrosion Measures	230
Powertrain Compartment	207	Environmental Factors Affecting the Rate of	
Coolant.....	208	Corrosion.....	230
Brake Fluid.....	209	Recycling and Environmental Protection	231
12V Battery	210	Material Recycling.....	231
Power Battery	213	Environmental Protection	231
Power Battery.....	213		
Windshield Wipers and Washer.....	215		
Windshield Wipers	215		
Windshield Washer	217		

Maintenance Overview

General Description

As the mileage on a vehicle increases, its components will gradually wear out and its technical condition will deteriorate. To ensure the vehicle maintains good performance and retains higher value upon resale, it is necessary to perform regular maintenance throughout the use of the vehicle.

Maintenance is divided into regular and daily maintenance. Regular maintenance should be carried out at a dealership, while daily maintenance is primarily the responsibility of the driver.

When performing any maintenance or inspection operations, it is essential to adhere to safety operation standards. Incorrect procedures may lead to functional failures or damage to the vehicle, and could even result in accidents.

Regular Maintenance Instructions

Timely regular maintenance is an essential part of vehicle usage. The interval for regular maintenance, whether in terms of mileage or time, as well as the maintenance items, should be carried out in accordance with the stipulations in the vehicle's warranty policy. Maintenance reminders displayed on the combination instrument panel should be used to visit a dealership for regular maintenance promptly, and the maintenance mileage reminder should be reset.

CAUTION

Failure to perform regular maintenance on time can reduce the vehicle's performance, cause damage, and also result in the loss of warranty claim rights.

Daily Maintenance Instructions

Daily maintenance refers to the checks that should be performed before driving each day. To ensure continuous normal operation of the vehicle, this is necessary. Performing daily maintenance is the responsibility of the driver.

Daily maintenance and checks can be carried out by the driver themselves, but if necessary, they can also be done at a dealership.

Daily Maintenance Precautions

Drivers must pay attention to safety and comply with safe operating practices during routine maintenance to prevent injury to themselves or damage to the vehicle.

Disassembly, replacement, or repair of vehicle parts should be carried out by professionals. If there are any questions about the vehicle's maintenance or repair, please consult a dealership.

WARNING

- Before performing daily maintenance, park the vehicle in a safe area on a flat surface, and engage the parking brake. Do not perform maintenance in areas with heavy traffic, pedestrian flow, near flammable or explosive hazards, or on slopes.
- Before maintenance, remove loose clothing, tie up long hair, remove bracelets, watches, and other jewelry, wear gloves, and take appropriate protective measures.
- Do not disconnect or connect the 12V battery cable or other electrical components when the vehicle is powered on.
- Keep objects with sparks, flames, or sparks away from the power battery and 12V battery.
- Avoid direct skin contact with used coolant.

WARNING

- Promptly remove foreign objects from the powertrain compartment during daily checks or regular maintenance. Do not leave inflammable items or tools in the powertrain compartment. Leftover items could cause drive motor failure or damage, even causing fire.
- The drive motor can produce high temperatures during operation, causing burns. Wait at least 30 minutes after the drive motor is turned off for it to cool before performing related maintenance.
- Do not go under the vehicle supported only by a jack. If necessary to go under the vehicle, use a proper safety stand.

Daily Maintenance Items

External Daily Maintenance Items

Perform daily maintenance before driving each day as described in this chapter.

If any unusual noises, vibrations, or smells are noticed, immediately check the cause or go to a dealership for repairs.

Follow the "Daily Maintenance Precautions" for any check or maintenance work.

Doors and Powertrain Compartment Lid

Check that all doors and the powertrain compartment lid operate normally.

Check that all door locks function properly. Lubricate hinges and latches if necessary.

Ensure that the powertrain compartment lid's safety hook still keeps it closed when the main lock is opened.

Vehicle Lights

Regularly clean front and rear headlights. Ensure that brake lights, turn signals, front headlights, and other lighting equipment operate normally and are securely fixed. Check that the headlight beam height is correct.

Tires

Before long trips, measure tire pressure with a pressure gauge. Adjust the pressure of all tires to the specified value if necessary. Carefully check tires for cuts, bulges, cracks, excessive wear, or other damage.

Wheel Rotation

It's recommended to interchange the front and rear tires in a cross pattern every 10,000 km. The interval for tire rotation may vary based on driving habits and road conditions.

Windshield

Regularly clean the windshield. Check at least every six months for cracks or other damage.

Air Conditioning Intake

Regularly clear leaves, flowers, pollen, and other debris from the ventilation grill. Especially in rainy or snowy weather, promptly remove snow from the ventilation grill to ensure the air intake and water channels are clear. Otherwise, the drainage outlet of the water channel may be blocked, affecting the air conditioning effect and even causing system failure.

If the ventilation grill is not cleaned for a long time, leaves, flowers, pollen, and other debris may mold, causing odors in the cabin.

Internal Daily Maintenance Items**Brake Pedal**

Check that the brake pedal operates normally. Ensure there is adequate clearance under the pedal when fully depressed, and ensure floor mats do not obstruct the pedal's operation.

Accelerator Pedal

Check that the accelerator pedal operates smoothly without resistance or uneven force. Ensure there is adequate clearance to the floor when the pedal is fully depressed, and ensure floor mats do not obstruct the pedal's operation.

Steering Wheel

Check for excessive free play, heavy steering, or other abnormal noises in the steering wheel.

Seat Belt

Check that all parts of the seat belt system (e.g., buckles, tongues, retractors) operate smoothly and are securely fitted. Check for cracks, abrasions, wear, or damage to the seat belts.

Warning Lights, Indicators, and Buzzers

Ensure all warning lights, indicators, and buzzers operate normally.

Windshield Defogger

When operating the air conditioning system, check that air is appropriately and sufficiently blowing from the defogger vents.

Wipers and Washers

Check that the wipers and washers operate normally and ensure the wiper blades do not leave streaks after use. Replace wiper blades if necessary.

Other Daily Maintenance Items**Drive Motor Coolant**

Check the coolant level in the reservoir tank when the drive motor has cooled.

Brake Fluid

Ensure the brake fluid level in the reservoir is between the MAX and MIN marks.

Windshield Washer Fluid

Check that there is enough washer fluid in the windshield washer fluid reservoir.

Fluid Leaks

After the vehicle has been parked for a while, check underneath for coolant or other fluid leaks. Dripping water after using the air conditioner is normal. If any leaks are noticed, check their cause and get them repaired immediately.

Powertrain Compartment Lid

Opening/Closing the Powertrain Compartment Lid

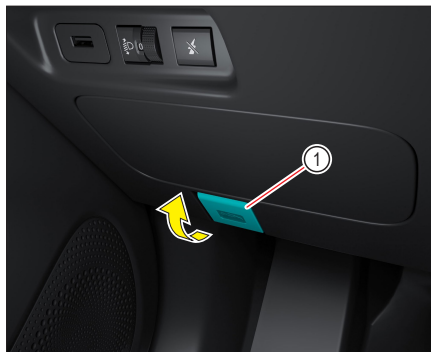

Powertrain Compartment Lid Opening

1. Pull the powertrain compartment lid release handle ① located under the left side of the dashboard until the lid pops up.

⚠ WARNING

- Before leaving the vehicle, ensure the powertrain compartment lid is closed. This vehicle is equipped with an automatic 12V battery charging feature. If the 12V battery is low and the vehicle is not used for a long time, the high-voltage system may automatically charge the 12V battery. Opening the powertrain compartment lid directly without opening the car door poses a risk of electric shock. It is safer to open the lid after ensuring it is closed and the car door is opened, as the high-voltage system automatically stops charging.

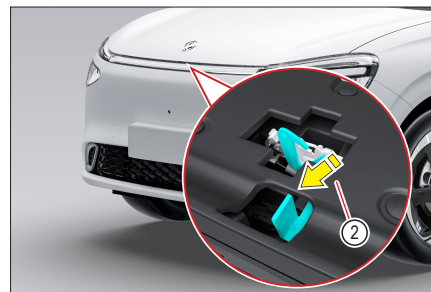

2. Locate the safety hook control lever ② between the powertrain compartment lid and the grille (on the lower right side facing the vehicle badge, as shown), and push the lever to the left with your finger to release the safety hook.



3. Lift the powertrain compartment lid ③ upwards.

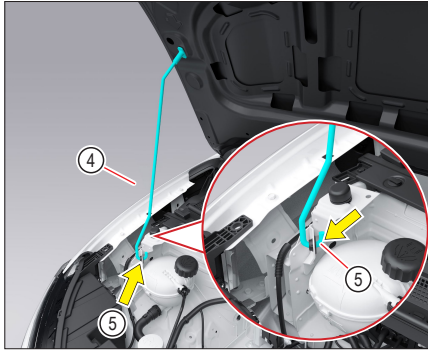

4. Stabilize the powertrain compartment lid and insert the support rod (4) into the support hole (5).

⚠ WARNING

- Ensure the end of the support rod is fully inserted into the support hole.
- Do not open the powertrain compartment lid in strong winds to prevent it from flipping over, causing damage to parts or injury.



Closing the Powertrain Compartment Lid

1. Check and confirm that there are no foreign objects left in the powertrain compartment to prevent damage to vehicle parts.
2. Steadily hold the lid, slightly lift it to release the support rod from the support hole, and then secure the support rod.
3. Gently lower the powertrain compartment lid to about 200mm above the front grille, release it, and let gravity lock it in place. After locking, press up and down on the lid to ensure it is securely locked.

⚠ WARNING

- Before closing the powertrain compartment lid, ensure the charging port cover is closed to avoid damaging it.
- Be cautious when closing the lid to prevent trapping someone else's fingers, especially children.
- Releasing the lid too high above the front grille or forcefully closing it can damage the headlights and front grille.
- Before driving, the powertrain compartment lid must be closed and locked. Otherwise, the oncoming wind during driving can open the lid, leading to a serious accident.
- If steam or smoke is coming from the powertrain compartment, do not open the lid to prevent injury.

Powertrain Compartment

Powertrain Compartment Layout

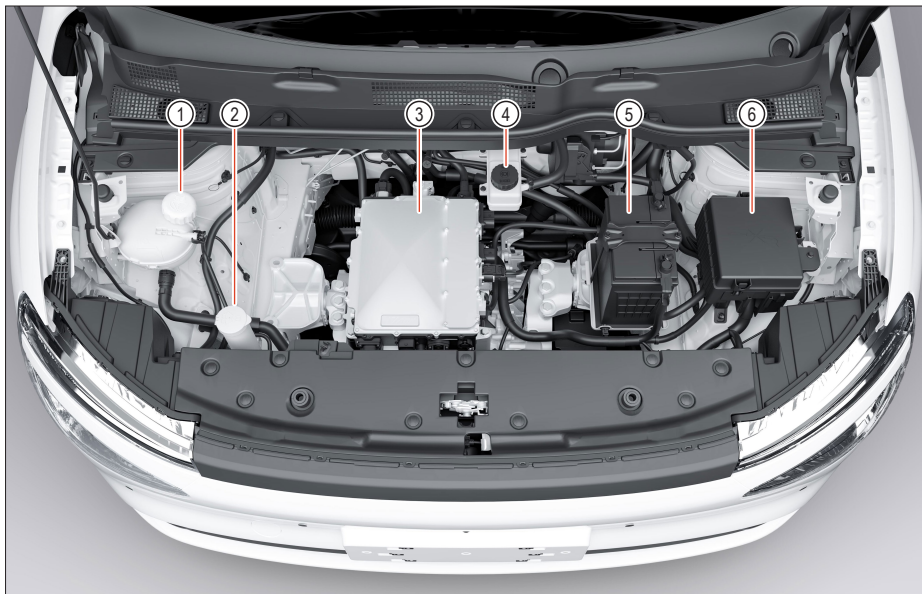

- ① Drive Motor Coolant Reservoir Filler Cap
- ② Windshield Washer Fluid Reservoir Filler Cap
- ③ High Voltage Integrated Controller
- ④ Brake Fluid Reservoir Filler Cap
- ⑤ 12V Battery
- ⑥ Powertrain Compartment Fuse Box

Safety Instructions for Working in the Powertrain Compartment

General Description

Working on or within the powertrain compartment, such as checking or adding fluids, can pose risks of fire or other accidents. Therefore, pay attention to the relevant warning instructions and safety regulations.

WARNING

- Never unlock the powertrain compartment cover while driving, as an unlocked cover may open during vehicle movement, obstructing the driver's view and causing serious accidents.
- Before opening the powertrain compartment lid, ensure that the windshield wiper is adhered to the windshield. Otherwise, the windshield wiper or powertrain compartment lid may be damaged.

WARNING

- When opening or closing the powertrain compartment cover, it may suddenly drop to the closed position. Be aware of the risk of injury to persons within the movement range of the cover. Therefore, open or close the cover only when there are no persons within its range of motion.
- Avoid touching live electrical components to prevent the risk of electric shock and injury.
- Even if the drive motor is turned off, the cooling fan may operate without warning, so as long as the powertrain hatch cover is opened, you must always be vigilant to avoid injury.

Powertrain Compartment

Coolant

General Description

The coolant serves to prevent corrosion, pitting leaks, radiator boiling, scale formation, and freezing, ensuring the cooling system is always in optimal working condition and maintaining the normal operating temperature of the drive motor.

WARNING

- Do not open the coolant reservoir filler cap before the drive motor has cooled down, as the coolant may be at a high temperature and opening it could result in hot coolant or steam spraying out, causing burns.
- Do not mix coolants of different types or brands, and do not add other liquids or additives to the coolant, as this may damage the drive motor.
- If the coolant in the reservoir appears discolored or changes color, it should be replaced immediately.

Drive Motor Coolant Level Check

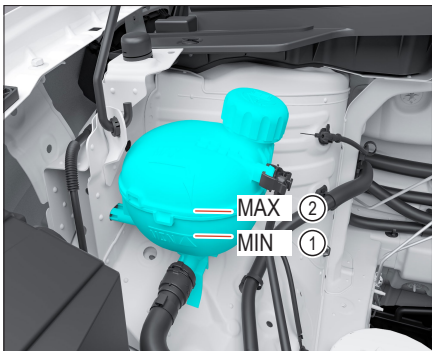

Check the coolant level after the radiator has cooled.

If the coolant level is below the MIN line ①, add coolant to between the MIN ① and MAX ② lines.

Coolant Replacement

Coolant should be replaced regularly in accordance with the vehicle's warranty policy. For coolant replacement, please visit an authorized dealership for service.

WARNING

- In winter or cold areas, replace with coolant suitable for the ambient temperature to prevent freezing damage to the drive motor.
- Store the coolant in a sealed container and keep it out of children's reach.

CAUTION

- The cooling system is filled with high-quality antifreeze and rust inhibitor at the factory. Therefore, other cooling system additives are unnecessary.
- Do not mix coolants of different types or brands, and do not add other liquids or additives to the coolant, as this may damage the drive motor.
- If the coolant level frequently drops, visit an authorized dealership for a vehicle inspection.

Brake Fluid

General Description

Brake fluid is used in the vehicle's hydraulic braking system to transmit pressure.

If the brake pedal travel unexpectedly increases or the brake fluid level drops significantly, visit an authorized dealership for brake system service.

CAUTION

- Brake fluid is highly hygroscopic and should be stored in a sealed container to prevent deterioration due to moisture absorption.
- Brake fluid can corrode car paint, so promptly clean any fluid that splashes onto painted surfaces.

WARNING

- Store brake fluid where children cannot access it. If brake fluid is ingested, seek medical attention immediately.
- Avoid contact with skin or eyes. In case of contact, rinse thoroughly with water and seek medical attention.
- Be careful not to spill brake fluid on the hot drive motor, as this could cause a fire.

Powertrain Compartment

Brake Fluid Level Check

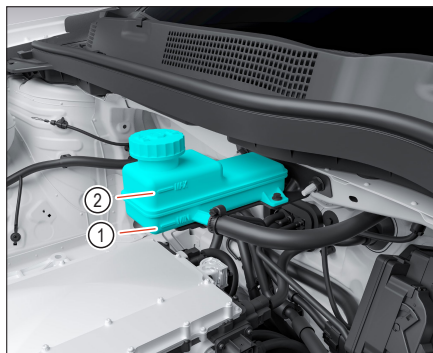

Check the fluid level in the reservoir. If the brake fluid level is below the MIN line ①, the brake system warning light will illuminate. Add brake fluid up to the MAX line ②.

If you need to add brake fluid frequently, have the system thoroughly inspected at an authorized dealership.

Brake Fluid Replacement







To ensure the proper functioning of the braking system, replace the brake fluid regularly according to the vehicle's warranty policy. For brake fluid replacement, please visit an authorized dealership.

WARNING

- Failing to replace the brake fluid as scheduled may lead to brake system failure and cause serious accidents.
- Do not drive the vehicle if the brake fluid level is below the reservoir's lower limit mark to avoid accidents.
- If brake fluid remains in the hydraulic system for many years without replacement, it can deteriorate, creating air resistance in the brake lines, affecting braking efficiency and safety, and may even lead to complete brake system failure, causing accidents.

12V Battery

12V Battery Operation Warning Symbols and Instructions

1		No open flames, sparks, bright lights, or smoking in the work area!
2		Protective eyewear must be worn during operation!
3		Children must be kept away from electrolyte and the vehicle's 12V battery!
4		The 12V battery electrolyte is highly corrosive; protective gloves and eyewear must be worn during handling!
5		Carefully read the 12V battery manual before starting work!
6		Explosive gases are produced while charging the 12V battery!

⚠ WARNING

- Keep open flames, sparks, or objects that may cause sparks away from the 12V battery.
- Do not short-circuit the 12V battery terminals, as the resulting high-energy sparks can injure the operator.
- Before handling the 12V battery, touch the car body to discharge any static electricity, to prevent sparking that could ignite the highly explosive gases in the 12V battery.
- The acid in the 12V battery is highly corrosive. Wear protective gloves and goggles. Do not invert the 12V battery, as acid may flow out from the vent holes.
- If acid splashes into the eyes, rinse with water for several minutes and seek medical attention immediately. If acid splashes onto the skin or clothes, absorb it with a dry cloth, then wash with soap and water. If acid is ingested, seek medical attention immediately.
- Keep children away from the acid and the 12V battery.

12V Battery Check

1. Check if the 12V battery is securely mounted.
2. Inspect the positive and negative cable terminals of the 12V battery for looseness or corrosion.
3. Examine the insulation layer of the positive and negative cables of the 12V battery for damage.
4. Keep the surface of the 12V battery dry and clean to prevent clogging of the ventilation holes.

If the vehicle is due for a long trip or the 12V battery has been in use for over a year, have the battery charge checked at an authorized dealership.

Jump Starting

If the battery is low on charge and the vehicle needs to be started by jump-starting.

If the vehicle still cannot be started by jump-starting or the 12V battery cannot be charged, replace the 12V battery. Please contact an authorized dealership for battery replacement.

12V Battery Charging

If the vehicle is parked for a long time without use, frequently started, or often driven short distances in cold environments, the 12V battery may become discharged and unable to start the vehicle, requiring additional charging. Please contact an authorized dealership for charging.

⚠ WARNING

- Do not charge the 12V battery while it is still connected to the vehicle, as this may severely damage the vehicle's electrical components.
- In cold environments, do not attempt to charge a frozen 12V battery, as there is a risk of explosion.

👁 CAUTION

- The vehicle is equipped with a 4G SIM card remote monitoring module. If the vehicle is parked in an area without 4G coverage, the quiescent current may be higher after the vehicle enters sleep mode, leading to the 12V battery discharging. Ensure the vehicle is parked in an area with good 4G coverage for extended periods.

Powertrain Compartment

Winter Protection

The starting power provided by the 12V battery at low temperatures is lower than that at normal temperatures. Therefore, before the start of winter, it is best to check the vehicle's 12V battery at an authorized dealer, and if necessary, charge or replace the 12V battery.

Under particularly cold weather conditions, the 12V battery requires a longer charging time. If the 12V battery is not sufficiently charged, the electrolyte in the 12V battery can freeze and damage the 12V battery. To ensure the efficiency of the 12V battery, it should be checked regularly.

If the vehicle is parked in extremely cold conditions for several weeks or longer, remove the 12V battery and store it in a room-temperature environment to protect it from freezing damage.

Long-Term Vehicle Inactivity

If the vehicle is not used for more than 15 days, disconnect the negative cable of the 12V battery and charge the battery every 15 days.

If the vehicle is not used for a long time without charging the 12V battery, the battery may become ineffective due to self-discharge.

12V Battery Replacement

Carefully read and follow the safety warnings regarding 12V battery operation before starting work.

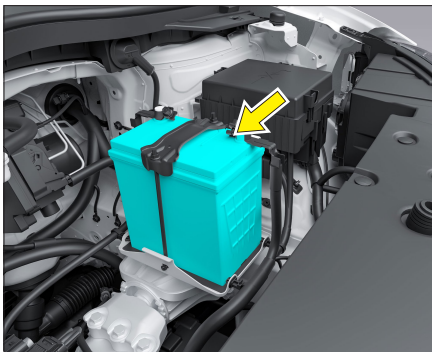

When replacing the 12V battery, ensure that it is correctly installed and securely fastened.

CAUTION

When removing the 12V battery, first disconnect the negative cable, then the positive cable. Before reconnecting the 12V battery, turn off all the electric devices. Connect the positive wire first, then the negative wire.

WARNING

- Only replace with a 12V battery of the same specification. Using a 12V battery of a different specification may result in improper installation or difficulties in connecting the battery cables due to variations in terminal positions. This could even lead to electrical component malfunctions or damage.
- The removal and installation of a 12V battery require specific professional skills and tools, as there is a risk of damaging the battery and the fuse box in some cases. It is recommended to have the 12V battery replaced at an authorized dealership.

Environmental Notice



12V batteries contain pollutants. Disposing of 12V batteries with regular household waste is illegal. They must be collected separately and recycled in an environmentally friendly manner.



Please dispose of 12V batteries in an environmentally responsible way. Depleted 12V batteries should be taken to an authorized dealership or a specialized battery recycling facility.

Power Battery

 **WARNING**

- Keep objects with sparks, flames, or sparks away from the power battery.
- Do not disassemble the power battery and related components yourself to avoid the risk of electric shock.

General Description

The primary power source of this vehicle is the power battery, which provides the necessary electrical energy for the drive motor and also powers high-voltage electrical components in the vehicle, such as air conditioning cooling and heating. The power battery needs to be charged via an external power source.

For new vehicles, the driving range may vary due to factors like driving habits (e.g., frequent rapid acceleration, use of brakes), road conditions (e.g., steep slopes, uneven roads), environmental conditions (e.g., low temperatures), and the use or non-use of electrical devices (e.g., air conditioning).

As a chemical product, the power battery is subject to natural capacity degradation due to its chemical properties. Therefore, for vehicles that have been used for some time, the pure electric mileage will decrease.

Safety

The power battery has undergone tests for high temperature, high voltage, impact, etc. and has excellent safety performance.

Maintenance

When the battery level gauge on the combination instrument is about to enter the red warning area, it indicates that the power battery is low on charge, and you should charge it as soon as possible. When the gauge enters the red warning area, it means that the power battery is severely depleted, and you should charge it immediately to prevent the vehicle from being unable to drive due to insufficient charge.

During the use of the vehicle, perform a full charge maintenance at least once a month.

When the vehicle is not in use for a long time, perform a charge-discharge cycle at least once every three months. The specific method is as follows: light up the READY light, turn on the air conditioning, discharge the vehicle's battery until the gauge pointer indicates the bottom of the red area, and then fully charge the power battery.

Do not wash the high-voltage components and power battery under the vehicle with water to avoid damaging the high-voltage components and power battery.

CAUTION

- The operating temperature range for the power battery is -30°C to 55°C. Operating outside this temperature range for extended periods will directly affect the vehicle's performance and the lifespan of the power battery.
- Keep the vehicle clean and avoid parking it in humid, high-temperature environments to prevent power battery failure or damage.
- Try to use the car charger to charge the vehicle, if the frequent fast charge of the power battery, it seriously affects the service life of the power battery.
- For new vehicles, before first use, fully charge the power battery to avoid impacting its performance.
- Do not stay inside the vehicle during charging.
- Park the vehicle in a ventilated area during charging.
- Avoid driving the vehicle when the battery is nearly depleted, as this can significantly reduce the vehicle's lifespan.

Toxic and Hazardous Components of the Power Battery

This power battery meets the requirements of "GB/T 30512-2014 Requirements for Prohibited Substances in Automobiles": Lead (Pb) or its compounds < 0.1% (1000mg/kg); Cadmium (Cd) or its compounds < 0.01% (100mg/kg); Mercury (Hg) or its compounds < 0.1% (1000mg/kg); Hexavalent Chromium (Cr⁶⁺) < 0.1% (1000mg/kg); Polybrominated Biphenyls (PBBs) < 0.1% (1000mg/kg); Polybrominated Diphenyl Ethers (PBDEs) < 0.1%.

Power Battery Storage Requirements

The power battery is stored in a partially charged state, generally at 50% to 70% SOC. The storage environment requirements are as follows:

- Storage temperature allowance: -40°C to 60°C, recommended to store within the normal temperature range of 20°C to 35°C;
- Storage humidity: Should be maintained within the range of 30% to 70%;

- Storage environment: The product should be stored in a clean, dry, ventilated, and cool environment, avoiding direct sunlight, high temperatures, corrosive gases, severe vibration, mechanical shock, and heavy pressure conditions; keep away from heat sources.

It can be stored in a dry and ventilated environment for 3 months. If it exceeds 3 months, disconnect the negative terminal of the 12V battery; if not charged timely after 6 months, the battery may be damaged. The following maintenance testing methods apply during product storage:

- Under normal temperature conditions, use AC slow charging to fully charge the product every three months, and adjust the State of Charge (SOC) to 50% to 70% after charging is complete.

Windshield Wipers

Wiper Blade Cleaning

Contamination of either the windshield glass or the wiper blades will reduce the effectiveness of the wipers. Main sources of contamination include dust, sand, insects, tree sap, and the water wax used in car washes. If the wiper blades do not clean effectively, use a high-quality cleaner or mild detergent to clean the windshield glass and wiper blades, and then rinse thoroughly with water. The steps for cleaning the wiper blades are as follows:

1. Lift the wiper arm away from the windshield.
2. Hold the wiper arm.
3. Carefully wipe away dust and dirt from the wiper blade and the surface of the windshield glass with a soft cloth.
4. After cleaning, gently place the wiper arm back in its original position.

 CAUTION

- To prevent streaks on the glass surface during wiping, regularly clean the wiper blades. Avoid using gasoline, kerosene, paint thinners, or other similar solvents to clean the wiper blades to prevent damage.
- If the windshield remains dirty after wiping, clean the wiper blades with a sponge or cloth. If they cannot be cleaned properly, replace the wiper blades.
- In cold weather, check if the wiper blades are frozen before using the windshield washer. Only use the windshield washer if the wiper blades are free of obstructions and hindrances.
- In hot summer or snowy weather, or when the vehicle is not in use for a long time, lift the wiper arms to slow down the aging of the wiper blades.

Wiper Blade Replacement

Regularly check and promptly replace damaged wiper blades to avoid scratching the windshield glass.

 CAUTION

- Avoid dry wiping without water to prevent wiper blade wear, damage, and scratching of the windshield glass, affecting driving safety.
- Wiper blades should be replaced once or twice a year.
- Do not turn on the power before completing the replacement of wiper blades to prevent sudden wiper movement, damaging the windshield and powertrain compartment cover.
- If lifting the wiper arm from the windshield glass, do not open the powertrain compartment cover or the back door; do not fold the windshield wiper arm back onto the windshield glass when the wiper blades are not installed to avoid damaging the windshield and wiper.

Windshield Wipers and Washer

Front Windshield Wiper Blade Replacement Method

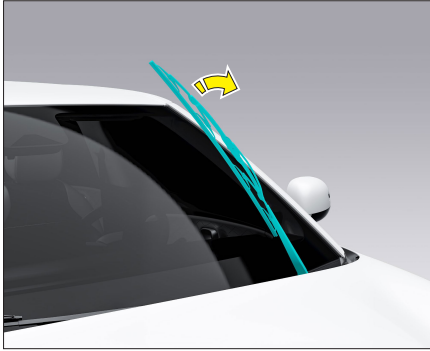

1. Lift the wiper arm away from the windshield. Place a thick towel under the lower part of the wiper arm to prevent accidental snapping back and damaging the windshield.

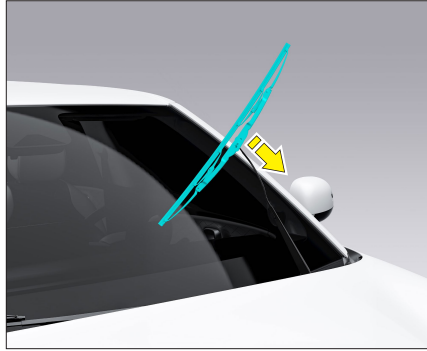

2. Rotate the wiper blade about 90 degrees.
3. Pull the wiper blade along the direction of the wiper arm to detach it.

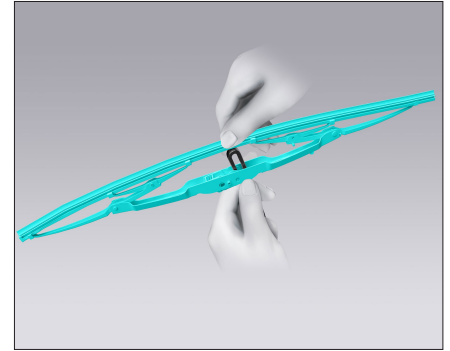

4. Replace with a new wiper blade.
5. Insert the wiper blade into the hook slot of the wiper arm.
6. Gently lower the wiper arm back onto the windshield.

Windshield Washer

Washer Nozzle Check

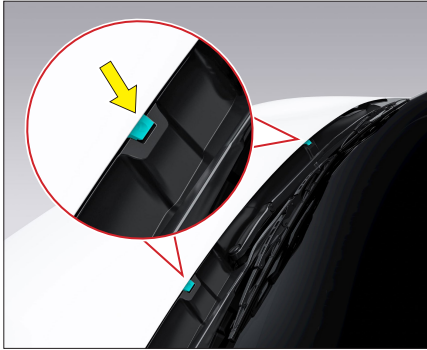

If there is debris near the washer nozzle, clean it promptly as it may affect the normal functioning of the windshield washer.

Turn on the vehicle's power, operate the wiper and washer switch to spray water, and observe the spray pressure and position. If the spray pressure is too low or the spray position is incorrect, take the vehicle to an authorized dealership for repair.

Adding Windshield Washer Fluid

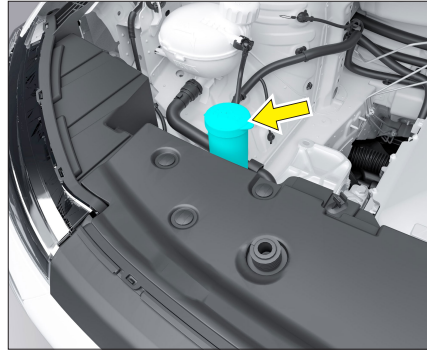

If using the windshield washer results in intermittent or no spray of washer fluid, it may indicate a lack of washer fluid. Check and, if necessary, add washer fluid to the reservoir promptly.

⚠ CAUTION

- In winter, to prevent freezing, use washer fluid with appropriate antifreeze properties.
- Windshield washer fluid is toxic and should be stored in a marked container out of reach of children.

Window Tinting Film for Car Windows*

Choosing Window Tinting Film*



Purple:Ultraviolet Light

Blue:Visible Light

Red:Infrared Light

CAUTION

- Do not overly pursue sun protection, heat insulation, and privacy at the expense of visibility. The light transmittance of the front windshield after applying the film must reach over 70% (i.e., the transmittance of the tint film multiplied by that of the car window glass), otherwise, it can significantly impair the driver's visibility and affect driving safety.
- If the window tinting film contains a high level of metal, it might interfere with signals.

7

Maintenance

The primary function of applying window tinting film to car windows is to reduce the irradiation of ultraviolet and infrared rays inside the car, while ensuring good visibility and privacy.

It is advisable to choose a window tinting film with high reflectivity for ultraviolet and infrared rays, and high transparency for visible light, which means higher clarity.

Tire and Wheel Inspection

Wheel and Tire Appearance Inspection

Before driving, check all four tires and regularly inspect the tread and sidewalls for bulges, scratches, abnormal wear, cracks, or nails. If any of these are present, contact an authorized dealership for inspection and replacement.

Tire damage can be difficult to detect. If abnormal vibrations, noise, or deviation in vehicle handling are noticed while driving, it may indicate a fault in one of the tires. In such cases, ensure safety first, then immediately stop the vehicle to inspect the wheels and tires for any damage. If necessary, contact an authorized dealership for tire repair.

Common causes of tire damage include:

- Impact or friction against curbs;
- Driving quickly over deep potholes;
- Tire pressure being too low or too high.

Regularly check the depth of the tread pattern across the entire width of the tire and the condition of the tread. Tread depth that is too low will reduce the tire's grip. Particularly on wet and slippery surfaces, this increases the risk of hydroplaning and significantly affects driving safety.



The wear indicator ① shows the safe limit of tire use. Replace the tire when the tread wears down to the wear indicator.

Check all wheels for valve caps and inspect the valve stems for dirt and air leaks. Do not install any parts on the valve stems.

Inspect the condition of the wheel rim. If the rim exhibits signs of warping, cracking, corrosion, or severe abrasions, it should be replaced immediately. If wheel bolts frequently loosen, replace the wheels and wheel bolts.

WARNING

Do not continue to drive with tires that show bulging or cracking, as this may lead to a blowout and cause a traffic accident and personal injury.

Tires and Wheels

Tire Pressure Check

General Description

Proper tire pressure extends tire life and improves the vehicle's driving comfort, economy, and handling stability.

Low tire pressure increases tire wear, significantly affects handling stability and fuel economy, and increases the risk of tire failure. High tire pressure leads to unstable driving, uneven tire wear, and reduced tire lifespan.

Check tire pressure at least once a month, and also after driving on rough roads or before long trips.

Check tire pressure when the tires are cold. Cold tires are those that have not been driven for at least 3 hours or have been driven less than 1.6 km.

Refer to the "Tire Information Label" for the standard cold tire pressure.

Checking Tire Pressure

Use a tire pressure gauge to check tire pressure when the tires are cold.



1. Remove the valve cap from the tire valve stem and check for air leaks using the soap solution method.

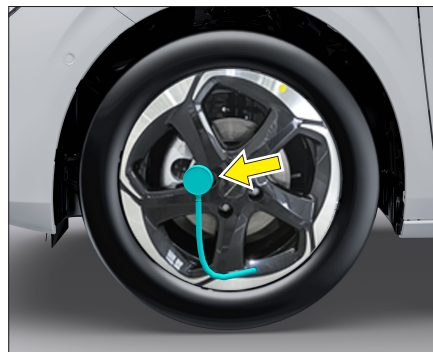

2. After attaching the tire pressure gauge to the valve stem, the gauge will display the tire pressure.
3. Check and adjust the tire pressure to meet the standard value.
4. After checking, be sure to put the valve cap back on the valve stem.

i NOTE

Apply a mixture of water and household detergent to the valve stem and observe if bubbles form, indicating a leak.

i NOTE

After driving for a while, tire pressure may rise by 0.2 to 0.5 bar. At this time, the tire pressure will be higher than the standard value. To ensure that the tire pressure measurement matches the standard, do not deflate the tires, as this will result in a lower pressure when the tires are cold.

⚠ WARNING

Continuously driving at high speeds with significantly low tire pressure can cause the tires to deform constantly, leading to overheating and possible tire blowouts.

Wheel Rotation

Regular wheel rotation aims to ensure even tire wear and extend the overall tire life. Rotate the wheels approximately every 10,000 km.

Before rotating wheels, check for damage to the tires and wheels. If there is no damage, proceed with wheel rotation and alignment.

👁 CAUTION

- When rotating wheels, ensure the front wheels are in better condition.
- If a tire shows uneven or excessive wear, visit an authorized dealership for wheel alignment.

i NOTE

If the tire pressure warning light remains on after wheel rotation, contact an authorized dealership for system calibration.

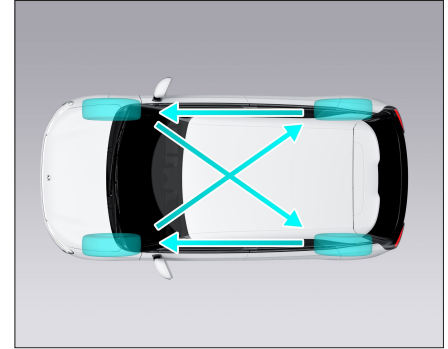

Rotate the wheels diagonally during wheel rotation.

After wheel rotation, ensure all wheel bolts are tightened to about 90N·m. Adjust all tires to the specified pressure. After driving 1,000 km, recheck the tightness of the wheel bolts.

WARNING

Dirt on the wheel and brake disc contact surface can cause wheel bolt loosening, leading to wheel detachment and traffic accidents. Therefore, when changing wheels, clean rust or dirt from the contact surface.

Wheel Dynamic Balance Check

Wheels are dynamically balanced at the factory, but several factors can affect wheel balance during use.

Dynamic imbalance in wheels can cause wheel wobble, abnormal tire wear, and impact driving stability. Regularly check wheel balance at an authorized dealership.

Tire Selection and Replacement

Buying New Tires

Check the vehicle's tire information label to understand the required tire model and size.

On the same axle, use tires of the same brand, model, size, pattern, and wear level.

CAUTION

After changing wheels, calibrate the tire pressure monitoring sensors for the new wheels, or the system may not receive tire pressure signals from that wheel, preventing warnings even if the tire is underinflated. If unable to perform calibration, contact an authorized dealership.

Tire Replacement

Replace tires if any of the following conditions occur:

- The tire wear indicator is visible.
- The cords or fabric in the rubber of the tire are visible.
- Cracks in the tread or sidewall deep enough to see the cords or fabric.
- Bulging, swelling, or delamination of the tire.
- The tire is punctured, cut, or damaged in a way that is difficult to repair.
- The tire's age reaches 6 years from the date of manufacture.
- When installing tires, follow the inner and outer markings on the tire sidewall.
- Perform dynamic balancing after patching or replacing a tire.

i NOTE

If wheels are replaced, a tire pressure monitoring system calibration is required. If the tire pressure warning light remains on, contact an authorized dealership.

⚠ WARNING

- Do not use old tires from unknown sources, as these may have invisible damage, potentially causing loss of vehicle control and accidents.
- New tires may not offer optimal road grip in the first 500 km, so drive at appropriate speeds to properly break in the new tires and prevent accidents.
- Tires age over time, even if not used. Regardless of remaining tread depth, replace tires after 6 years.
- Frequent driving in hot environments or overloading can cause tires to overheat and age faster, reducing tire life. Check tires more frequently to prevent sudden blowouts and accidents.
- Mixing different brands, structures (radial and bias tires), sizes, and patterns of tires can adversely affect braking and handling, potentially causing accidents.

Winter Tires*

i NOTE

Winter tires significantly improve vehicle handling stability on icy and snowy roads. It's recommended to install winter tires when temperatures drop below -7°C.

⚠ CAUTION

Before purchasing winter tires, consult an authorized dealership about potential impacts on the vehicle's warranty.

⚠ WARNING

- If installed winter tires have a maximum allowable speed lower than the vehicle's maximum design speed, post a corresponding warning label within the driver's view.
- Do not exceed the maximum allowable speed of the winter tires. Exceeding this speed can cause sudden tire deflation, shedding, or even blowouts, leading to accidents!

Tires and Wheels

It's advised to use winter tires of the same size as the original tires, and all four tires should be replaced.

In winter, installing winter tires greatly improves vehicle handling stability.

Once the temperature rises above 7°C, immediately switch to summer tires, as they offer better handling stability than winter tires on non-icy, non-snowy roads.

Handling a Blowout

The vehicle uses tubeless tires, and blowouts are uncommon during normal driving, even less so with proper tire maintenance. However, in the event of a blowout, take the following measures:

- If a front tire blows out, the vehicle will pull to the side of the deflated tire. Immediately release the accelerator, firmly hold the steering wheel to control the direction, keep the vehicle in its lane, lightly press the brake pedal, stop the vehicle in the emergency lane or a safe place, use tire repair tools, and visit the nearest dealership to replace the tire.
- If a rear tire blows out, the vehicle may experience abnormal vibration and noise but can still be steered. Release the accelerator, steer in the desired direction to maintain control, lightly press the brake, stop the vehicle in the emergency lane or a safe place, use tire repair tools, and visit the nearest dealership to replace the tire.

Rim Replacement

Replace rims if they are twisted, deformed, cracked, corroded, or have severe scratches. Also, replace rims if tire leakage is due to rim damage (except for some repairable aluminum rims).

The load capacity, specifications, offset distance, and installation dimensions of new rims should match the original rims, and the installation method should be the same.

 **CAUTION**

Perform dynamic balancing after rim replacement.

⚠ WARNING

- Using inappropriate rims can affect the vehicle's braking and handling, potentially causing the tire to detach from the rim and leading to loss of vehicle control and accidents.
- Using non-conforming rims may reduce the bearing life, brake cooling, speedometer and odometer calibration, vehicle ground clearance, and clearance between the tires or tire anti-skid chains and the vehicle body and chassis.
- There is also a risk in using old wheels on a vehicle. Since it is impossible to know how old wheels have been used and how many miles they have traveled, they may have invisible cracks that can cause accidents while driving.

Anti-Skid Chains

Do not install unapproved anti-skid chains. Inappropriate snow chains can damage the vehicle's tires, wheels, brakes, and body. When using them, please pay attention to the following requirements:

- Suitable anti-skid chain size for vehicle wheel size should be selected;
- 9mm specification anti-skid chains are recommended;
- Anti-skid chains can only be installed on the drive wheels (front wheels);
- Please follow the anti-skid chain installation instructions and speed limits for different road conditions.
- To prevent tire damage and excessive wear of the chains, be sure to remove the anti-skid chains when driving on non-snowy roads.

⚠ WARNING

- Comply with relevant regulations when driving with anti-skid chains, and do not exceed a speed of 40km/h.
- Remove the anti-skid chains on roads without ice and snow.

👁 CAUTION

This manual provides technical reference information for the use of snow tires and anti-skid chains. Snow tires and anti-skid chains are not included in the vehicle's equipment range.

Vehicle Cleaning

Exterior Cleaning

When to Wash Your Vehicle

Wash your vehicle in the following circumstances to protect the body paint:

1. After driving in the rain. Acid rain can damage the surface paint.
2. After driving on coastal roads. Sea water erosion can cause body rust.
3. When contaminants such as soot, bird droppings, tree sap, metal particles, or insects are left on the body surface.
4. When there are clumps of dust or mud on the body surface.

Washing Method

Use a wet sponge and plenty of water to wash off the dirt from the car.

Thoroughly wash the vehicle with a mixture of neutral soap water or detergent (special car wash soap or general dishwashing detergent) and clean, mild water.

Rinse the vehicle with enough clean water.

After washing the vehicle, wipe it with a special cloth (chamois) to avoid spots after it dries.

CAUTION

- Joints, doors, windows, and powertrain compartment covers are most susceptible to road deicing salt corrosion. Therefore, these areas must be wiped clean regularly.
- Ensure that the drainage holes under the doors are clear.
- Rinse the bottom and wheels of the car with water before washing it, making it easier to wash off mud, salt, and other dirt.
- Do not use strong household soaps, powerful chemical degreasers, or solvents to clean the vehicle's surface.
- Do not wash the vehicle when its body surface is very hot, as this can cause water spots on the paint.
- Do not use hard leather or rough cloth to clean the body.

Washing Precautions

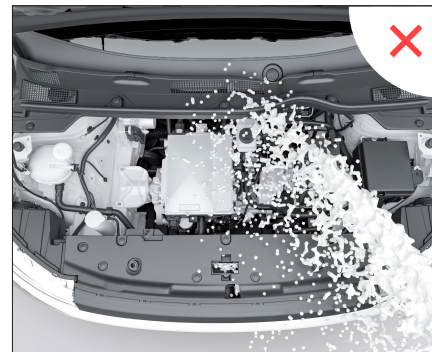

CAUTION

- Do not rinse the powertrain compartment, vehicle charging port, and high-voltage components of the chassis (such as high-voltage batteries) with water, as it may cause faults in electrical circuits, drive motors, power batteries, and other components.
- Do not clean the charging cable connectors and plugs to prevent terminal corrosion.
- Do not allow water or other liquids to come into contact with the interior electrical components, as this may damage them.

WARNING

Do not use gasoline, turpentine, nail polish remover, or other volatile liquids to maintain the vehicle. These substances are toxic and flammable and can easily cause fire and explosion!

Removing Stains

Remove tar or other oil stains, industrial dirt, insect stains, and resin from the lower part of the vehicle promptly to prevent damage to the paint or leaving stains.

Waxing the Vehicle

Regular waxing can protect the vehicle's paint surface and help maintain its appearance.

Mechanical friction or intense polishing on the primer/clear coat layers can cause imperfections or leave swirl marks on the paint.

After waxing, polish to remove residues from the surface and prevent weathering.

CAUTION

- Thoroughly wash the vehicle before waxing.
- Use car wax according to the manufacturer's instructions.
- Do not use waxes containing abrasives, mixtures, or detergents, as they may damage the body paint.

Cleaning Exterior Glass

When cleaning dirt off the windshield glass with the wiper, spray windshield washer fluid on the glass surface before wiping. Otherwise, it can damage the wiper blades and the glass surface.

Even in light rain, spray before wiping.

Use windshield washer fluid sold at authorized dealerships.

Maintenance of the Vehicle's Underbody

In areas where deicing salt is used in winter, regularly clean the underside of the car to prevent dirt or adhered salt from corroding the underbody and suspension system components.

In winter or spring, check the vehicle's sealing condition and reseal if necessary.

Cleaning Aluminum Alloy Wheels

Regularly clean aluminum alloy wheels, especially in areas where deicing salt is used on roads in winter. Salt on the wheels can corrode the aluminum alloy and cause discoloration.

CAUTION

To avoid staining or fading the wheels, follow these guidelines:

- Do not use cleaners containing strong acids or alkalis to clean the wheels.
- Do not use wheel cleaners when the wheels are hot. The wheel temperature should be the same as the ambient temperature.
- Rinse the wheels within 15 minutes after using the cleaner to wash off the cleaner thoroughly.

Vehicle Cleaning

Cleaning the Wheels

Clean the wheels when washing the vehicle to maintain a clean appearance.

When changing wheels or cleaning the underside of the vehicle, clean the inside of the wheels.

Do not use abrasive cleaners to clean the wheels.

Regularly check for dents or erosion on the wheel rims. This could lead to pressure loss or tire edge damage.

It is recommended to wax the wheels to protect them from corrosion caused by deicing salt used on roads in winter.

Cleaning Chrome Parts

Regularly clean chrome parts with a non-abrasive chrome polish to maintain their shine.

Interior Cleaning

Regularly use a vacuum cleaner or duster to remove dust and dirt from inside the vehicle (such as on interior trim, plastic parts, and seats). To clean dirt off plastics or leather, dampen a clean, soft cloth in mild soapy water, wipe, and then dry with a soft cloth.

To maintain the appearance of leather, heed the manufacturer's instructions. Some protectants may contain chemicals that could spoil or corrode the leather coverings. Wipe leather surfaces with a soft cloth dampened with just a small amount of water.

CAUTION

- Do not use any light petrol, thinners, or similar liquids for wiping.
- Small dirt particles can wear and damage the leather surface and should be removed immediately. Do not use leather soap, car wax polish, cleaners, solvents, stain removers, or cleaners containing ammonia, as they can damage the natural sheen of the leather.

CAUTION

- Do not use fabric protectants unless recommended by the manufacturer.
- Avoid using glass and plastic cleaners on leather surfaces, as they could cause damage.

Floor Mats*

Using floor mats can extend the life of the vehicle's carpet and make cleaning easier.

Regardless of the type of floor mats used, ensure they are suitable for your vehicle and are securely fixed to avoid interfering with pedal operation.

WARNING

Unsecured floor mats can slide and potentially obstruct the brake and accelerator pedals, leading to serious accidents.

Wiping Inside of Vehicle Glass

When wiping the inside of the glass, do not use tools with blades or chlorine-based disinfectants, as they can damage the rear window glass defogger wires.

In winter, when the inside of the glass fogs up, apply a suitable amount of specialized glass anti-fog spray to prevent fogging.

Seat Belts

The webbing of seat belts can be washed with a sponge dampened in neutral detergent.

After cleaning, the seat belt webbing should be completely dried before use. Do not retract wet webbing into the retractor, as it could damage the retractor.

Do not use bleach, dyes, or chemical solvents to clean seat belt webbing, as these can severely damage the webbing.

Leather Seat Covers

Leather seats are high-quality products. With proper care, leather covers will maintain good performance.

Dust and dirt accumulation over time can affect the luster of the leather and cause wear and aging, so regular maintenance and cleaning are essential.

When the leather surface is very dirty, wipe it with a damp cloth or diluted soapy water. If water is spilled on the leather surface or stays in the seams, wipe it off promptly.

It is recommended to use regular brand leather care products and avoid prolonged exposure of leather seats to strong light.

WARNING

- Do not use solvents or strong cleaning agents to clean leather.
- When installing seat covers, do not cover the outer side of the seat back where the side airbags are located, as this could affect the inflation and expansion of the side airbags.

Vehicle Corrosion Prevention

Anti-Corrosion Measures

Ensuring the Vehicle is Corrosion-Free

- Regularly wash and wax the vehicle to keep it clean.
- Frequently inspect for minor paint damage and repair it promptly.
- Check the underside of the car for accumulations of sand, dirt, or salt, and wash them off with water as soon as possible.

CAUTION

- Do not use water to directly wash the passenger compartment to remove dirt, sand, or other debris. Instead, use a vacuum cleaner or broom to remove the dirt.
- Avoid water or other liquids coming into contact with the interior electrical components, as this can damage them.

De-icing agents and snow-melting chemicals used on roads are corrosive and can accelerate the aging and corrosion of underbody components such as exhaust systems, parking brake control cables, brake lines, floor panels, and fenders. Therefore, after driving on such roads, the underside of the vehicle should be cleaned promptly.

Other rust and corrosion prevention measures may have specific requirements in some regions. Consult an authorized dealership for more information.

Most Common Factors of Vehicle Corrosion

- Accumulation of damp dirt or debris in the body panel cavities or other areas.
- Damage to paint or other protective coatings caused by sand and pebbles or minor traffic accidents.

Environmental Factors Affecting the Rate of Corrosion

Moisture

Accumulations of grit, dirt, and moisture under the body can accelerate body corrosion. Damp carpets inside the vehicle can take a long time to dry completely, and to prevent floor corrosion, they should be removed and dried.

Relative Humidity

In areas with high relative humidity, corrosion can accelerate.

Temperature

Higher temperatures can accelerate the corrosion of parts in poorly ventilated conditions, especially in areas where the temperature remains above freezing.

Air Pollution

Industrial pollution, the presence of salt in the air in coastal areas, or the extensive use of salt on roads can accelerate corrosion. Salt on roads can also speed up the flaking of paint.

Material Recycling

Plastics

Plastics and rubber parts are marked according to current regulations for easy recycling. To facilitate recycling, the range of materials used has been limited: most plastics are thermoplastic materials that can be recycled through melting, granulation, and crushing.

Metals

100% recyclable and reusable.

Glass

Can be disassembled and processed by glass manufacturers.

Rubber

Crushed tires and seals can be used for waterproofing rolls, rubber tracks, and other purposes.

Environmental Protection

Entrusting maintenance to an authorized dealership can control various pollution hazards, contributing to environmental protection.

Scrapped or Damaged Parts

These should not be discarded casually. Authorized dealerships have measures for recycling and environmental protection.

Waste Fluids

Authorized dealerships are responsible for collecting and processing these. Entrusting them with replacements can control various pollution hazards.

Discarded 12V Batteries and Remote Control Batteries

Do not dispose of 12V batteries and remote control device batteries carelessly, as they are harmful to the environment. Please take them to an approved collection point.

Discarded Power Batteries

Used power batteries should be handed over to the waste battery recycling points of authorized dealerships. These dealerships then hand them over to enterprises with relevant qualifications as stipulated by national laws and regulations for centralized recycling and processing. Do not discard or store them carelessly to avoid environmental pollution and safety hazards.

7

Maintenance

8. Technical Data

General Technical Characteristics	234
Overall Dimensions	236
Specification and Capacity of Main Liquids	237
Vehicle Identification.....	238
Vehicle Identification Number and Product Label	238
Microwave Window	239
Event Data Recording System (EDR)	240

General Technical Characteristics

Body Type		5-door, 5-seater, monocoque						
Overall Dimensions (mm)	Length	4030	Braking Performance	Driving brake 50km/h (unladen/laden)	Minimum distance (m)	Approx. 12.5		
	Width	1810			Average deceleration (m/s ²)	Approx. 7.5		
	Total Height (unladen)	1570			Brake stability (m)	Approx. 3.5m		
	Wheelbase	2660		Driving brake 100km/h (unladen/laden)	Minimum distance (m)	Approx. 4.9		
	Front Track	1540			Average deceleration (m/s ²)	Approx. 7.5		
	Rear Track	1540			Brake stability (m)	Approx. 3.5m		
Kerb Weight (kg)	Front Axle Load	728 (DFM7000A2F3BEV) / 745 (DFM7000A2F4BEV)	Wheel Alignment Parameters	Parked Vehicle Load	Static (20% slope)	5min		
		523 (DFM7000A2F3BEV) / 579 (DFM7000A2F4BEV)			Dynamic (30km/h)	Approx 1.5 m/s ²		
	Total Weight	1251 (DFM7000A2F3BEV) / 1324 (DFM7000A2F4BEV)		Front Wheel Alignment	Wheel Camber	-0°16'±0°30'		
Maximum Permitted Total Weight (kg)	Front Axle Load	852 (DFM7000A2F3BEV) / 869 (DFM7000A2F4BEV)	Kingpin Inclination		13°2'±0°45'			
		Rear Axle Load	774 (DFM7000A2F3BEV) / 830 (DFM7000A2F4BEV)	Kingpin Caster	5°39'±0°30'			
Maximum Permitted Total Weight (kg)	Rear Axle Load	774 (DFM7000A2F3BEV) / 830 (DFM7000A2F4BEV)	Rear Wheel Alignment	Kingpin Inclination	13°2'±0°45'			
		Total Weight		1626 (DFM7000A2F3BEV) / 1699 (DFM7000A2F4BEV)	Toe-in	0°8'±0°5'		
	Power Battery	Power Battery Type	LFP (Lithium Iron Phosphate)	Tires and Rims	Main Tire	Wheel Camber	-1°1'±0°30'	
Energy (kWh)			31.45 (DFM7000A2F3BEV) / 42.3 (DFM7000A2F4BEV)			Toe-in	0°10'±0°10'	
			Nominal Voltage (V)			307 (DFM7000A2F3BEV) / 304 (DFM7000A2F4BEV)	Tire Model	215/60 R16
Front /Rear Overhang (mm)		724 / 646		Passability		Rim Model	16×6.5J	17×7J
		Front Suspension System	MacPherson Independent Suspension System			Load Index	99(775kg)	98(750kg)
			Rear Suspension System			Torsion Beam Non-independent Suspension System	Speed Rating	V (240km/h)
Rear Suspension System	Torsion Beam Non-independent Suspension System	Steering System		Pressure (kPa)	250			
			EPS (Electric Power Steering System)	Material	Steel; Aluminum Alloy			
				Minimum Turning Diameter (m)	10.2			
Rear Suspension System	Torsion Beam Non-independent Suspension System	Steering System	Minimum Ground Clearance (mm)	135				
			EPS (Electric Power Steering System)	Approach Angle (°)	23 (Kerb) /21 (Laden)			
				Departure Angle (°)	30 (Kerb) /23 (Laden)			

General Technical Characteristics

Drive Layout	Front Engine, Front Wheel Drive, Two-wheel Drive	
Drive Motor	Drive Motor Type	Permanent Magnet Synchronous Motor
	Peak Power (kW)	70
	Rated Power (kW)	30
	Maximum Speed (rpm)	13000
	Rated Speed (rpm)	4100
	Peak Torque (N·m)	160
	Rated Torque (N·m)	70
Performance	Top Speed (km/h)	140
	Acceleration Time (0~50km/h) (s)	5.3
	Overtaking Acceleration Time (50~80km/h) (s)	6.3
	Maximum Gradeability (%)	30
Economy	WLTC Range (km)	237 (DFM7000A2F3BEV) / 317 (DFM7000A2F4BEV)
Brake Booster Type		Vacuum Assistance / Electronic Assistance
Front Brake Disc Thickness (mm)	Standard Value	25
	Wear Limit Value	23
Front Brake Pad Thickness (mm)	Standard Value	17
	Wear Limit Value	9
Rear Brake Disc Thickness (mm)	Standard Value	12
	Wear Limit Value	10
Rear Brake Pad Thickness (mm)	Standard Value	15.6
	Wear Limit Value	8
Wheel Imbalance (g)	Aluminum Wheel	≤10
	Steel Wheel	
Brake Pedal Force (N)		≤500
Free Travel (mm)		5 ~ 20
Brake Pedal Initial Position to Carpet Distance (Vertical Height) (mm)		143.9±6
Trunk Volume (L)		309

Overall Dimensions

Dimension unit: mm

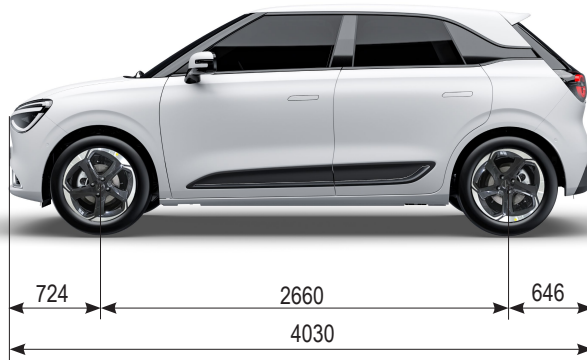
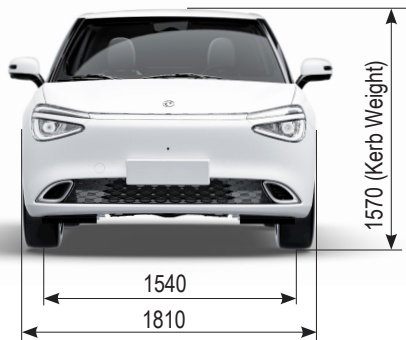

Specification and Capacity of Main Liquids

The following contents are approximate values, and the actual consumption will be slightly different. Please follow the instructions in the "Maintenance" section to decide the appropriate addition amount.

Fluids	Fluid Name	Type/Grade	Per Vehicle Usage
Drive Motor	Drive Motor Coolant	Ethylene Glycol Coolant, Freezing Point -40°C	2.6±0.5 L
Reducer	Reducer Lubricant	Total HBVFE-2	500±50 ml
Brake Fluid Reservoir	Synthetic Brake Fluid	DOT4	E1, E1+, E2: 800±50 ml E3: 880±50 ml
Air Conditioning	Refrigerant	R134a	520±10 g
Windshield Washer Fluid Reservoir	Windshield Washer Fluid	Ethanol Type, Freezing Point -25°C	1L

Note:

- The contents of this table are the design values, and the actual consumption manufacturers have the right to adjust according to the changes of products, equipment and climate.
- Please refer to the quality assurance policy of this vehicle for technical requirements and reasonable replacement cycle of brake fluid.

Vehicle Identification

Vehicle Identification Number and Product Label



MFD BY DONGFENG MOTOR CO.			
VIN:			
VEHICLE TYPE:	GVW:		
MOTOR TYPE:	MOTOR POWER:		
POWER BATTERY VOLTAGE/CAPACITY:	V/	Ah	
MFD DATE:	MADE IN CHINA	SEATS:	

- Vehicle product sign location: right B pillar outer plate.

Model and serial number of driving motor



- Inside the powertrain compartment, lift the vehicle to see the drive motor model located in front of the drive motor.
- Below the model of the drive motor is the serial number.

The vehicle identification code (frame number) VIN is the unique identification code of the vehicle, which can be viewed at 6 locations:

- The VIN code (A) is located in the front left of the dashboard and can be seen through the windshield;
- Open the back door, located in the back door inner plate, you can see the VIN code of the vehicle;
- VIN Stamping Location: Under the front passenger seat, on the surface of the front crossbeam beneath the carpet;
- The VIN code of the vehicle is also available on the left/right B-pillar inner panel and the left/right rear wheel housing inner panel reinforcing panel.

Microwave Window



The microwave window is located around the rearview mirror in the car, and communication equipment, such as ETC, access control, intelligent parking and other equipment, can be installed in this area. Solar film is not allowed in this area to ensure the effective reading of data.

Vehicle Identification

Event Data Recording System (EDR)

The vehicle is equipped with an Event Data Recording System (EDR). The implementation carrier of the system is an airbag ECU, which is mainly used to monitor, collect and record the data of the vehicle and occupant protection system before, during and after collision events (collisions or other physical events that reach or exceed the trigger threshold, or any other events that cause the deployment of airbags, air curtains, seat belt pretensioner, etc., whichever occurs first). This data will help to understand the operation of vehicle system.

To read the data recorded by the motor Vehicle Event Data Recording System (EDR), specialized equipment is required and access to the vehicle or motor vehicle Event Data Recording System (EDR) is required. In addition to automobile manufacturers, other third parties with professional equipment, such as law enforcement parties, can read the corresponding information if they have the right to use the vehicle or automobile event data recording system (EDR).

- Event Data Recording System (EDR) data reading device model: X431-PRO5 diagnostic instrument.
- Access to Event Data Recording System (EDR) data reading equipment: EDR system data extraction tools are provided by suppliers specified by the competent department, and can be purchased from franchise stores or suppliers.

In case of a serious collision accident with airbag deployment, the data stored in EDR will be locked and cannot be overwritten. Other collision data will be overwritten by the latest accident data.

The vehicle accident recording system in this vehicle records the following data:

NO.	Name	Data Usage Explanation
1a	Longitudinal delta-V	Represents the change in vehicle's longitudinal speed. Longitudinal delta-V is only the longitudinal component of the total delta-V.
2a	Maximum Recorded Longitudinal delta-V	Represents the maximum cumulative change in vehicle speed in the X-axis direction recorded by the EDR. This data should be used in conjunction with "Time to Maximum Recorded Longitudinal delta-V".
3a	Time to Maximum Recorded Longitudinal delta-V	Along the X-axis, the time from zero point to the occurrence of the maximum cumulative speed change recorded by the EDR. This data should be used in conjunction with "Maximum Recorded Longitudinal delta-V".
4b	Clipping Flag	Indicates the time point when an accelerometer first reaches the maximum value within the specified range.
5	Vehicle Speed	Vehicle speed obtained from wheel edge linear speed or other methods.
6	Driving Brake, On or Off	Used to detect whether the driver has depressed the brake pedal.
7	Driver Seat Belt Status	Records the status of the driver's seat belt buckle switch.
8c,d	Accelerator Pedal Position, Percentage of Full Open Position	Records the actual position of the accelerator pedal as a percentage of the fully depressed position by the driver.

Other ManualsLib Projects



www.manualslib.com



www.manualslib.de



www.manualslib.es



www.manualslib.fr



www.manualslib.nl



www.manualslib.mx



www.manualslib.tech 30+ Languages